

# hushjet mini cool

## User guide

SV12 JN.00000 PN.000000-00-00  
00.00.00 VERSION NO.01



---

### Contents

In the box

Get to know your machine

Getting started

Battery and LED behavior

Charging and LED behavior

Airflow direction

Accessories

Accessories sold separately

Looking after your machine

Care and guidance

Support and service

**dyson**

# In the box



Dyson HushJet™ Mini Cool fan

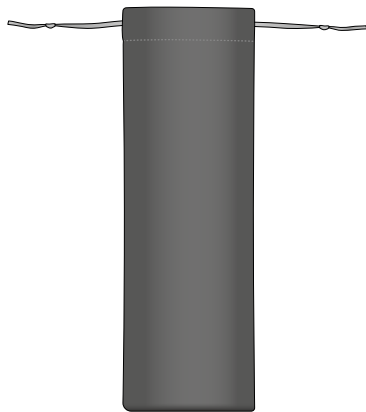

Travel pouch

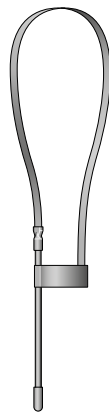

Neck dock

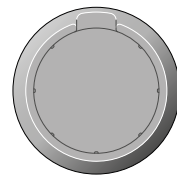

Charging stand

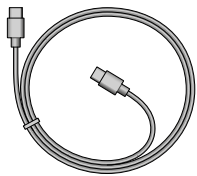

USB-C charging cable

---

Additional accessories available for purchase at [www.dyson.com](http://www.dyson.com)



Universal mount

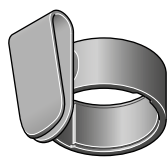

Grip clip

# Get to know your machine

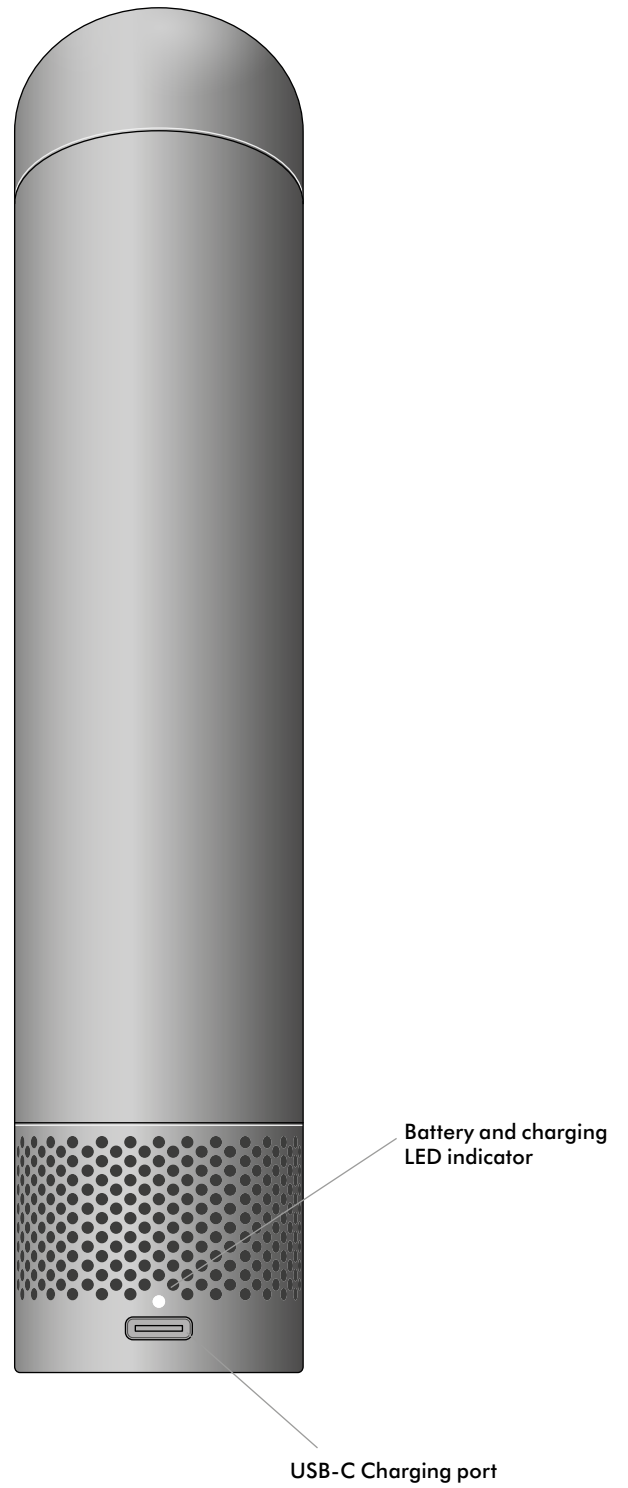
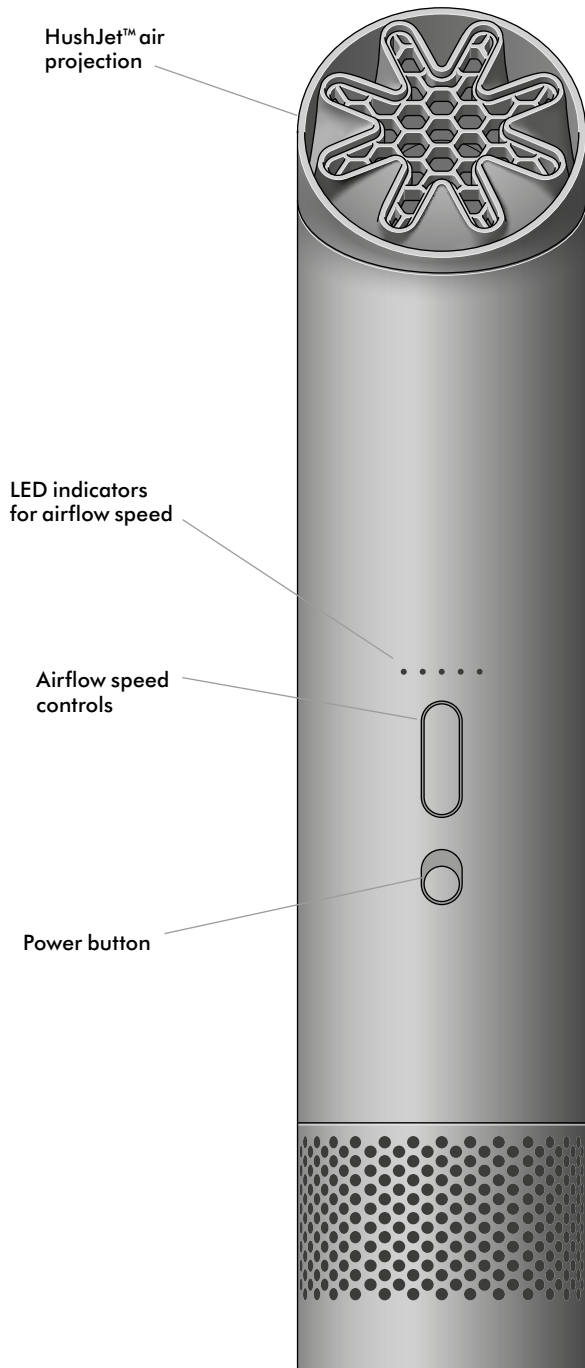

# Getting started

## Power switch – On

Slide the switch up to power on your machine.

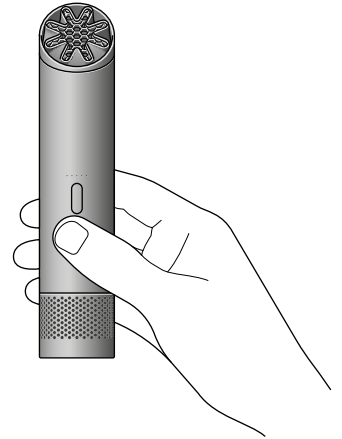
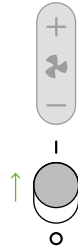

## Power switch – Off

Slide the switch down to power off your machine. All LED lights should turn off.

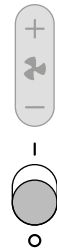

## Adjust airflow speed

Press the up and down buttons to increase and decrease airflow speed. The LEDs will light up white to indicate the current airflow speed.

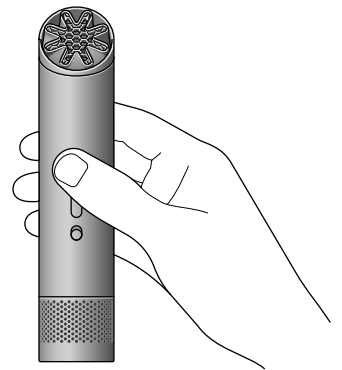

## Boost mode

When on fan speed 5, press and hold the Up button to enable Boost mode for extra turbo-charged power. All LEDs will pulse while Boost mode is enabled.



# Battery and LED behaviour

## Low battery

Locate the battery charge LED indicator on the rear of the machine.

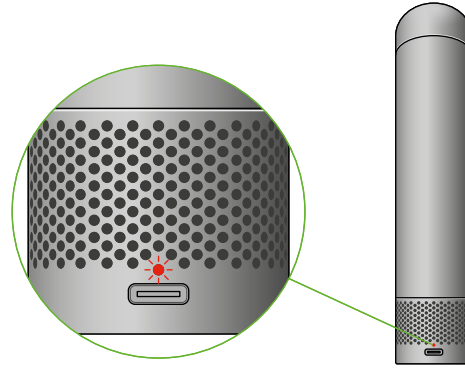

---

### Battery is less than 5% charged

The LED will flash red.



---

### Battery is 5%-20% charged

The LED will turn solid red.



## Check battery level

Ensure the power button is in the off position.

Press the up button to see battery level indicated by the 5 LEDs on the front of the machine.

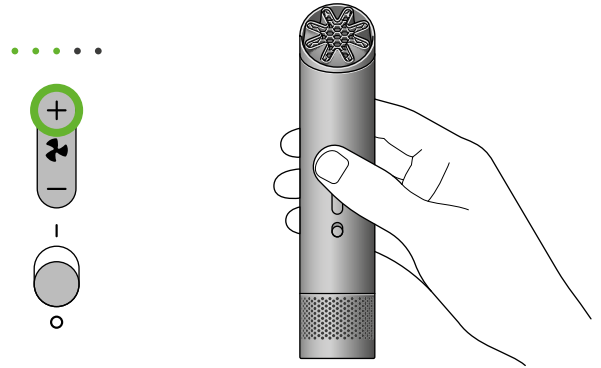

---

### Battery is charged 0%-20%

One LED will turn solid white.



---

### Battery is charged 20%-40%

Two LEDs will turn solid white.



---

### Battery is charged 40%-60%

Three LEDs will turn solid white.



---

### Battery is charged 60%-80%

Four LEDs will turn solid white.



---

### Battery is charged 80%-100%

All five LEDs will turn solid white.



# Charging and LED behaviour

Connect USB-C charging cable

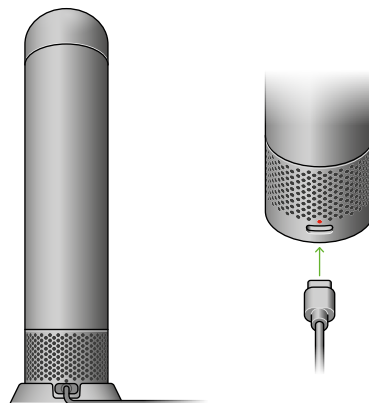

---

## Battery is charging

The rear LED will pulse white.

---



---

## Battery is fully charged

The rear LED will turn solid white.

---



---

## Battery is charging 0%-20%

One front LED will blink white.

---



---

## Battery is charging 20%-40%

One front LED will turn solid white.  
The next LED will blink white.

---



---

## Battery is charging 40%-60%

Two front LEDs will turn solid white.  
The next LED will blink white.

---



---

## Battery is charging 60%-80%

Three front LEDs will turn solid white.  
The next LED will blink white.

---



---

## Battery is charging 80%-100%

Four front LEDs will turn solid white.  
The next LED will blink white.

---



---

## Battery is 100% charged

All five front LEDs will turn solid white.  
The rear LED will turn solid white.

---



# Airflow direction

## Forward facing air projection

Airflow is directed forwards at a 30° angle – ideal when using on the Charging stand or in Handheld mode.

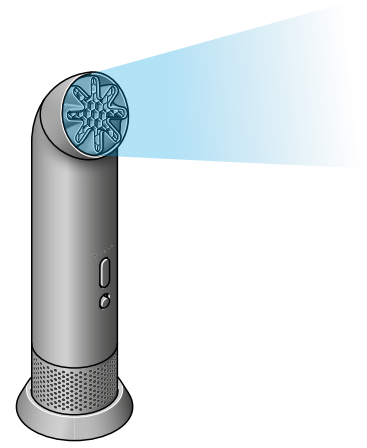

## Twist nozzle

Change the direction of airflow by simply twisting the nozzle.

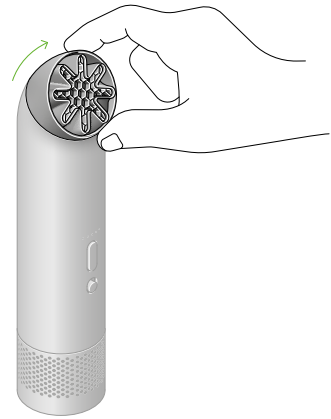

## Upward facing air projection

Airflow is directed upwards – for use when worn on the Neck dock.  
(See Accessories)

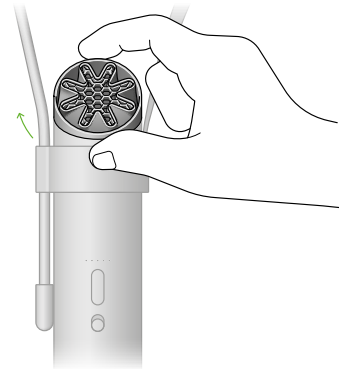

# Accessories

## Using the Neck dock

Secure your HushJet™ Mini Cool fan through the collar of the Neck dock. Use the cord to adjust to the desired length.

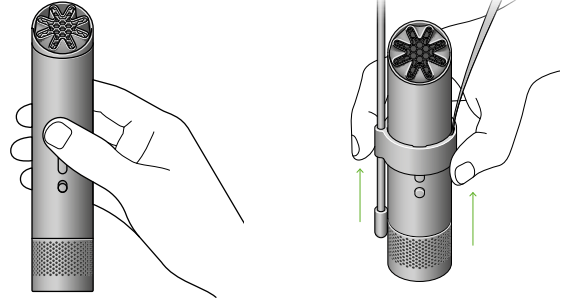

Twist the nozzle so it directs airflow towards your face.

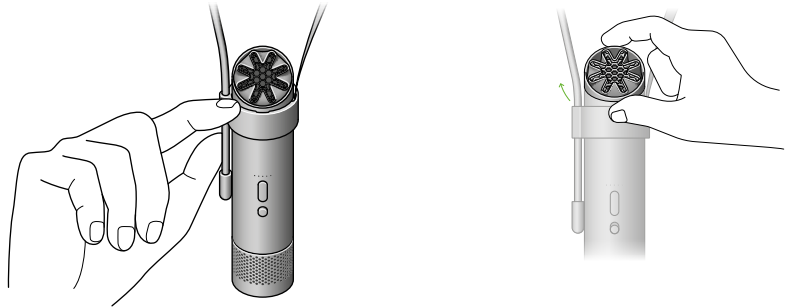

## Using the Charging stand

Place your HushJet™ Mini Cool fan onto the Charging stand for enhanced stability when using on a desk. Use the USB-C cable for charging.

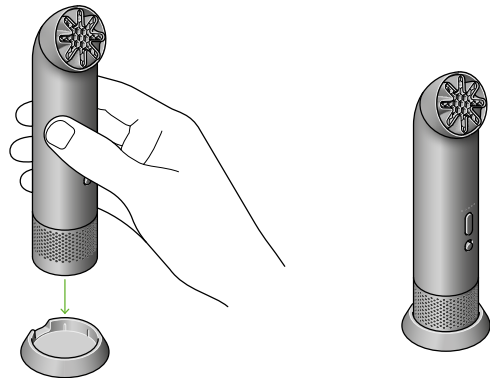

# Accessories sold separately

Subject to availability, additional tools can be purchased at [Dyson.com](https://www.dyson.com).

## Using the Universal mount

Take the Universal mount and attach it securely to a handle such as on a stroller.

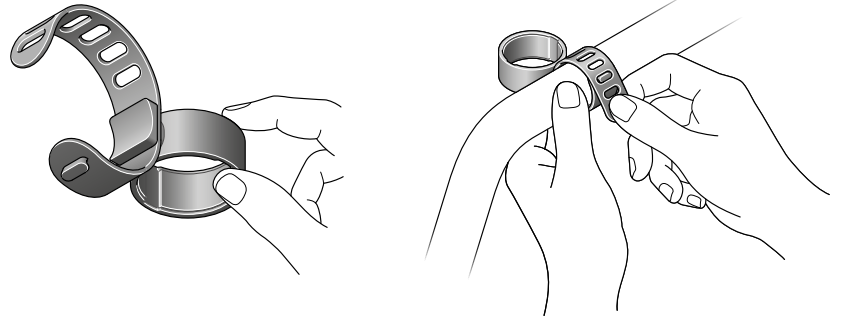

Take the HushJet™ Mini Cool fan and slide it through the collar of the mount until it sits under the nozzle.

Take the HushJet™ Mini Cool fan and slide it through the collar of the Universal mount until it sits under the nozzle.

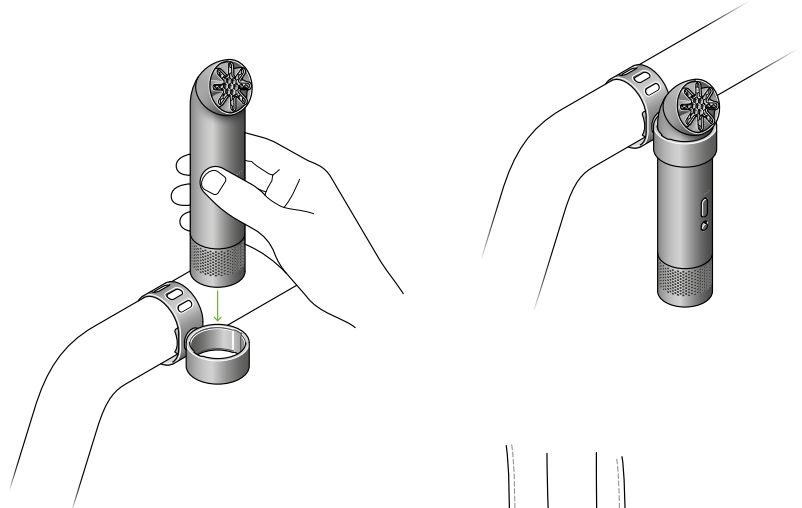

## Using the grip clip

Attach the Grip clip to a strap such as a backpack. Slide the HushJet™ Mini Cool fan through the clip until it sits under the nozzle.

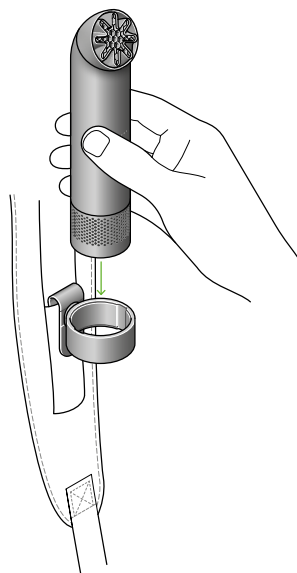
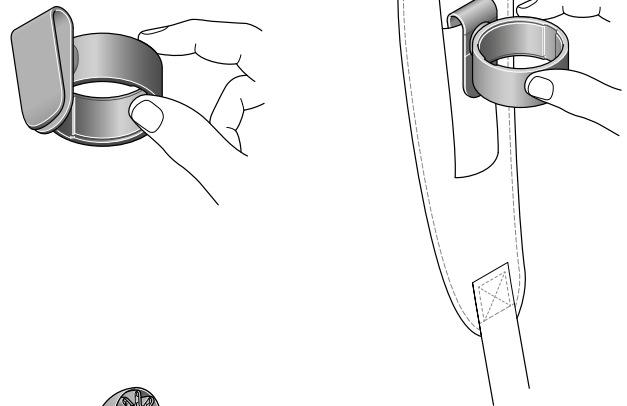

# Looking after your machine

## Cleaning the nozzle

To clean the nozzle of the HushJet™ Mini Cool fan, use a soft brush and gently dust around the nozzle.

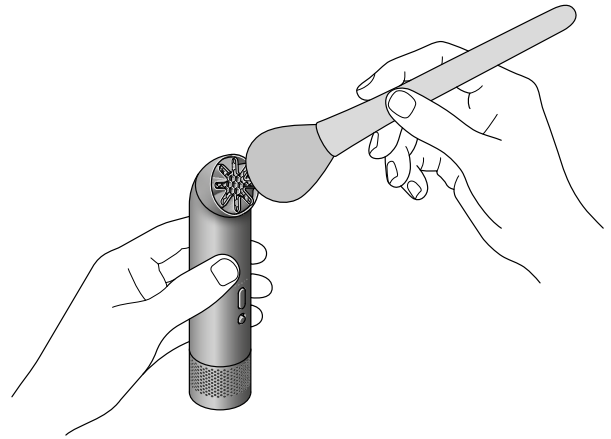

## Cleaning the machine

To clean your machine, wipe with a dry lint-free cloth.

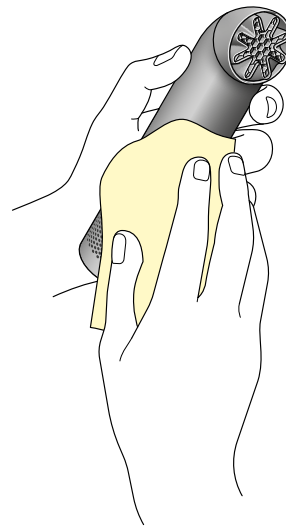

# Care and guidance

## Airflow restriction

Ensure you hold the fan above the inlet at the bottom as this can affect the machine's performance if blocked.

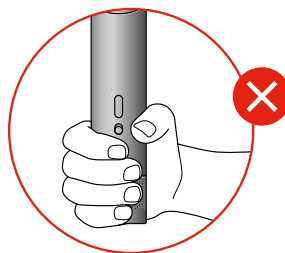

## Travel

Your machine contains lithium-ion batteries. When travelling, ensure it is stored with your carry-on luggage. You should not transport your machine in checked baggage.

Always check with your airline for any specific restrictions and the most current policies before your flight.

## Factory reset

If you encounter any errors such as incorrect LED displays, then perform a factory reset by holding both Up and Down buttons down for 10 seconds while your machine is turned on.

All LEDs will blink six times to indicate that your machine has been reset. The machine airflow speed will then return to speed one.

If the problem persists then contact our support team (see below).

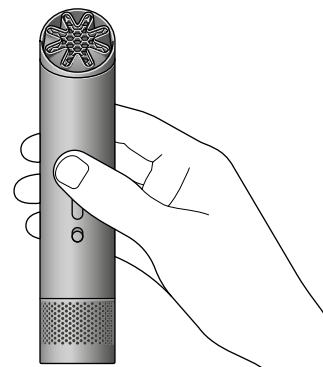
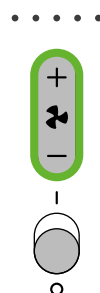

---

# Support and service

Visit [dyson.com/support](https://www.dyson.com/support) for videos, tips, and spare parts ordering.

Contact Dyson Customer Care for assistance.