



CRAIG®

10.1 INCH PORTABLE DVD/CD PLAYER

Owner's Manual



PLEASE READ BEFORE OPERATING THIS EQUIPMENT.

Model: CTFT751tk

Size: 148.5(W) x 210(H)mm (A5)



IMPORTANT SAFETY INSTRUCTION

	CAUTION RISK OF ELECTRIC SHOCK DO NOT OPEN	
<p>CAUTION: TO REDUCE THE RISK OF ELECTRIC SHOCK, DO NOT REMOVE COVER (OR BACK). NO USER-SERVICEABLE PARTS INSIDE. REFER SERVICING TO QUALIFIED SERVICE PERSONNEL.</p>		

CAUTION:
THIS DIGITAL VIDEO DISC PLAYER EMPLOYS A LASER SYSTEM.
TO ENSURE PROPER USE OF THIS PRODUCT, PLEASE READ THIS OWNER'S MANUAL CAREFULLY AND RETAIN FOR FUTURE REFERENCE. SHOULD THE UNIT REQUIRE MAINTENANCE, CONTACT AN AUTHORIZED SERVICE LOCATION-SEE SERVICE PROCEDURE.
USE CONTROLS, ADJUSTMENTS OR THE PERFORMANCE OF PROCEDURES OTHER THAN THOSE SPECIFIED HEREIN MAY RESULT IN HAZARDOUS RADIATION EXPOSURE.
TO PREVENT DIRECT EXPOSURE TO LASER BEAM, DO NOT TRY TO OPEN THE ENCLOSURE. VISIBLE LASER RADIATION MAY BE PRESENT WHEN THE ENCLOSURE IS OPENED. DO NOT STARE INTO BEAM.

WARNING:
TO REDUCE THE RISK OF FIRE OR ELECTRIC SHOCK, DO NOT EXPOSE THIS PRODUCT TO RAIN OR MOISTURE.

WARNING:
TO REDUCE THE RISK OF FIRE OR ELECTRIC SHOCK, AND ANNOYING INTERFERENCE, USE THE RECOMMENDED ACCESSORIES ONLY.



The lightning flash with arrowhead symbol within an equilateral triangle is intended to alert the user to the presence of uninsulated dangerous voltage within the product's enclosure that may be of sufficient magnitude to constitute a risk of electric shock to persons.



The exclamation point within an equilateral triangle is intended to alert the user to the presence of important operating and maintenance(servicing) instructions in the literature accompanying the appliance.



DANGER:
Invisible and hazardous laser radiation when open and interlock failed or defeated. Avoid direct exposure to beam.

FCC NOTICE:

This equipment has been tested and found to comply with the limits for a Class B digital device, pursuant to part 15 of the FCC Rules. These limits are designed to provide reasonable protection against harmful interference in a residential installation. This equipment generates, uses and can radiate radio frequency energy and, if not installed and used in accordance with the instructions, may cause harmful interference to radio communications.

However, there is no guarantee that interference will not occur in a particular installation. If this equipment does cause harmful interference to radio or television reception, which can be determined by turning the equipment off and on, the user is encouraged to try to correct the interference by one or more of the following measures:

- Reorient or relocate the receiving antenna.
- Increase the separation between the equipment and receiver.
- Connect the equipment into an outlet on a circuit different from that to which the receiver is connected.
- Consult the dealer or an experienced radio/TV technician for help.

FCC WARNING:

To assure continued compliance, follow the attached installation instructions and use only shielded cables when connecting to other devices. Modifications not authorized by the manufacturer may void user's authority to operate this device.

IMPORTANT SAFETY INSTRUCTION

Before using the unit, be sure to read all operating instructions carefully. Please note that these are general precautions and may not pertain to your unit.

For example, this unit may not have the capability to be connected to an outdoor antenna.

1) Read these instructions.

All the safety and operating instructions should be read before the product is operated.

2) Keep these instructions.

The safety and operating instructions should be retained for future reference.

3) Heed all warnings.

All warnings on the product and in the operating instructions should be adhered to.

4) Follow all instructions.

All operating and use instructions should be followed.

5) Do not use this apparatus near water.

Do not use this product near water and moisture, for example: near a bathtub, washbowl, kitchen sink or laundry tub; in a wet basement; or near a swimming pool.

6) Clean only with dry cloth.

Unplug this product from the wall outlet before cleaning. Do not use liquid cleaners or aerosol cleaners. Use a dry cloth for cleaning.

7) Do not block any ventilation openings. Install in accordance with the manufacturer's instructions.

Slots and openings in the cabinet and in the back or bottom are provided for ventilation, to ensure reliable operation of the product and to protect it from overheating. These openings must not be blocked or covered. The openings should never be blocked by placing the product on a bed, sofa, rug or other similar surface. This product should never be placed near or over a radiator or heat source. This product should not be placed in a built-in installation such as a bookcase or rack unless proper ventilation is provided or the manufacturer's instructions have been adhered to.

8) Do not install near any heat sources such as radiators, heat registers, stoves, or other apparatus (including amplifiers) that produce heat.

9) Do not defeat the safety purpose of the polarized or grounding-type plug. A polarized plug has two blades with one wider than the other. A grounding type plug has two blades and a third grounding prong. The wide blade or the third prong are provided for your safety. If the provided plug does not fit into your outlet, consult an electrician for replacement of the obsolete outlet.

10) Protect the power cord from being walked on or pinched particularly at plugs, convenience receptacles, and the point where they exit from the apparatus.

11) Only use attachments/accessories specified by the manufacturer.

12) Use only with the cart, stand, tripod, bracket, or table specified by the manufacturer, or sold with the apparatus. When a cart is used, use caution when moving the cart/apparatus combination to avoid injury from tip-over.

An appliance and cart combination should be moved with care.

Quick stop, excessive force and uneven surfaces may cause the appliance and cart combination to overturn.



13) Unplug this apparatus during lightning storms or when unused for long periods of time.

To protect your product from a lightning storm, or when it is left unattended and unused for long periods of time, unplug it from the wall outlet and disconnect the antenna or cable system. This will prevent damage to the product due to lightning and power-line surges.

14) Refer all servicing to qualified service personnel. Servicing is required when the apparatus has been damaged in any way, such as power-supply cord or plug is damaged, liquid has been spilled or objects have fallen into the apparatus, the apparatus has been exposed to rain or moisture does not operate normally, or has been dropped.

15) Power source

This product should be operated only from the type of power source indicated on the marking label. If you are not sure of the type of power supply to your home, consult your appliance dealer or local power company. For products intended to operate from battery power, or other source, refer to the operation instructions.

16) Power lines

An outside antenna system should not be located in the vicinity of overhead power lines or other electric light or power circuits, or where it can fall into such power lines or circuits. When installing an outside antenna system, extreme care should be taken to keep from touching such power lines or circuits as contact with them might be fatal.

IMPORTANT SAFETY INSTRUCTION

17) Overloading

Do not overload wall outlets and extension cords as this can result in a risk of fire or electric shock.

18) Object and liquid entry

Never push objects of any kind into the product through openings as they may touch dangerous voltage points or short out parts that could result in fire or electric shock. Never spill or spray any type of liquid on the product.

19) Outdoor antenna grounding

If an outside antenna is connected to the product, be sure the antenna system is grounded so as to provide some protection against voltage surges and built up static charges. Section 810 of the National Electric Code ANSI/NFPA 70 provides information with respect to proper to grounding of the mast and supporting structure, grounding of the lead-in wire to an antenna discharge product, size of grounding conductors, location of antenna-discharge product, connection to grounding electrodes and requirements for the grounding electrodes.

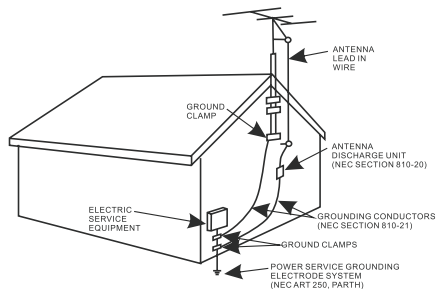

20) Service

Do not attempt to service this product yourself as opening or removing covers may expose you to dangerous voltage or other hazards. Refer all servicing to qualified service personnel.

21) Replacement parts

When replacement parts are required, be sure the service technician uses replacement parts specified by the manufacturer or those that have the same characteristics as the original parts. Unauthorized substitutions may result in fire or electric shock or other hazards.

22) Safety check

Upon completion of any service or repairs to this product, ask the service technician to perform safety checks to determine that the product is in proper operational condition.

23) Wall or ceiling mounting

The product should be mounted to a wall or ceiling only as recommended by the manufacturer.

24) Damage requiring service

Unplug this product from the wall outlet and refer service to qualified service personnel under the following conditions.

- When the power-supply cord or plug is damaged.
- If liquid has been spilled or objects have fallen into the product.
- If the product has been exposed to rain or water.
- If the product does not operate normally by following the operating instructions. Adjust only those controls that are covered by the operating instructions, as an adjustment of other controls may result in damage and will require extensive work by a qualified technician to restore in the product to its normal operation.
- If the product has been dropped or the cabinet has been damaged.
- When the product exhibits a distinct change in performance—this indicates a need for service.

25) Note to CATV system installer

This reminder is provided to call the CATV system installer's attention to Article 820-40 of the NEC that provides guidelines for proper grounding and, in particular, specifies that the cable ground shall be connected to the grounding system of the building, as close to the point of cable entry as practical.

NOTE: Refer all servicing to qualified service personnel. Servicing is required when the unit has been damaged in any way such as the following: the power-supply cord or plug has been damaged, liquid has been spilled into unit, the unit has been exposed to rain or moisture, the unit has been dropped or the unit does not operate normally.

IMPORTANT SAFETY INSTRUCTIONS

NOTES ON HANDLING:

- When shipping the unit, always use the original shipping carton and packing materials. For maximum protection, repack the unit as it was originally packed at the factory.
- Do not use volatile liquids, such as insect spray, near the unit. Do not leave rubber or plastic products in contact with the unit for a long time. They will leave marks on the finish.
- The top and rear panels of the unit may become warm after a long period of use. This is normal and not a malfunction.
- When the DVD player is not in use, be sure to remove the disc and turn off the power.

NOTES ON LOCATING THE DVD PLAYER:

- When you place this unit near a TV, radio or VCR, the playback picture may become poor and the sound may be distorted. In this case, move the unit away from the TV, radio or VCR.

NOTES ON CLEANING:

Use a soft, dry cloth for cleaning

- For stubborn dirt, soak the cloth in a weak detergent solution, wring well and wipe. Use a dry cloth to wipe it dry. Do not use any type of solvent, such as thinner and benzene, as they may damage the surface of the unit.
- If you use a chemical-saturated cloth to clean the unit, follow that product's instructions.

Warning: Cleaning and adjustment of lenses and /or other components of playback mechanism should be performed by a qualified service technician.

NOTES ON MOISTURE CONDENSATION:

Moisture condensation damages the DVD player Please read the following carefully.

- Moisture condensation occurs, for example, when you pour a cold drink into a glass on a warm day. Drops of water form on the outside of the glass. In the same way, moisture may condense on the optical pick-up lens inside this unit, one of the most crucial internal parts of the DVD player.

Moisture condensation occurs during the following cases:

- When you bring the DVD player directly from a cold place to a warm place.
- When you use the DVD player in a room where you just turned on the heater, or a place where the cold wind from the air conditioner directly hits the unit.
- In summer, when you use the DVD player in a hot and humid place just after you moved the unit from an air conditioned room.
- When you use the DVD player in a humid place.

Do not use the DVD player when moisture condensation may occur.

- If you use the DVD player in such a situation, it may damage discs and internal parts. Remove the disc, connect to power, turn on the DVD player and leave it ON for two or three hours. After two or three hours, the DVD player will have warmed up and evaporated any moisture.

ABOUT DISCS

The region number for this DVD Player is:
See the followings for information regarding region numbers.



PLAYABLE DISCS:

The following discs can be played back on this DVD player:



DISC TYPES:

DVD

Data on most DVDs is divided into sections called titles and then into subsections called chapters, each of which is given a title or chapter number. Some features of this DVD player will not operate with some DVD discs as they are preset. If a function you selected does not run as desired, refer to the manual accompanying the DVD disc.

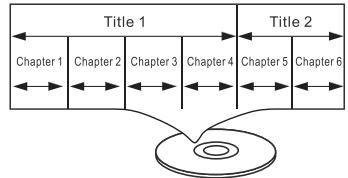

AUDIO CD

Data on an audio CD is divided into sections called tracks, each of which is given a track number.

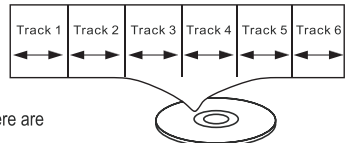

IMPORTANT:

It is important that you read the manual that accompanies the DVD disc, as there are features that are on the DVD player that cannot be used with certain DVDs.

There are also extra features on the DVD disc that are different for each DVD disc, so they are not explained in this owner's manual.

This player conforms to the NTSC and PAL color systems. However, if you are in the USA, Canada or Mexico, leave this setting on NTSC. If incorrectly set to PAL, the TV picture may roll vertically. In this case, set the TV system to NTSC.

Notes on Copyright:

It is forbidden by law to copy, broadcast, show, broadcast on cable, play in public and rent copyrighted material without permission. DVD video discs are copy protected, and any recordings made from these discs will be distorted. This product incorporates copyright protection technology that is protected by method claims of certain U.S. Patents and other intellectual property rights owned by Macrovision Corporation, and is intended for home and other limited viewing uses only, unless authorized by Macrovision Corporation. Reverse engineering or disassembly is prohibited.

Region Management Information:

This DVD Player is designed and manufactured to respond to the Region Management Information that is recorded on a DVD disc. If the Region number described on the DVD disc does not correspond to the Region number of this DVD player, this DVD player cannot play that disc. You may not be able to play back some DVD video discs on this player if they were purchased from outside your geographic area or made for business purposes. When you try to play back an unauthorized disc, Wrong Region appears on the TV screen.

LOCATION OF CONTROLS

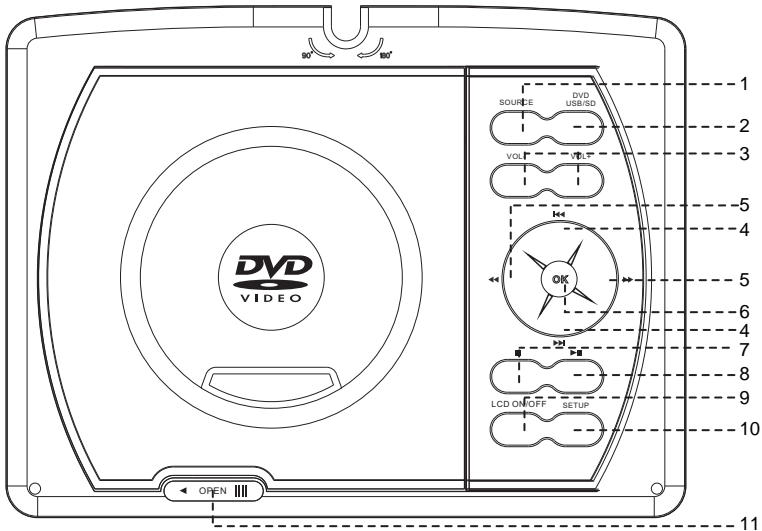

1. **SOURCE:**
~ Press to switch to AV IN mode; press again to resume normal mode.
2. **DVD/USB/SD:**
~ When USB device and/or SD Card was inserted, press repeatedly to select the playback source as desired.
3. **VOL (Volume)-:**
~ Press to decrease the volume level.
VOL (Volume)+:
~ Press to increase the volume level.
4. **◀◀ ▶▶**
~ In disc playback mode, press repeatedly to skip to previous/next chapters/tracks as desired.
~ In setting menu, press repeatedly to move the cursor upward or downward within the menu.
5. **◀▶**
~ In disc playback mode, press to fast forward or fast backward.
~ In setting menu, press repeatedly to move the cursor left and right within the menu or return to previous menu.
6. **OK:**
~ Press to confirm the selection.
7. **■**
~ While DVD/CD playing, press this button once to pre-stop (In this mode, when press the Play/Pause ▶| button again. The player will start to play the point you were stopped).
~ Or press the Stop ■ button twice to stop playback completely (In this mode, when press the Play/Pause ▶| button again. The player will start to play the current disc from beginning).
8. **▶|**
~ When playing, press this button to pause. Press again to resume normal playback.
9. **LCD ON/OFF**
~ Press to turn on/off the display.
10. **SETUP:**
~ In audio playback or AV out mode, press this button to turn off the screen to save the battery power. Press again to turn back the screen.
11. **OPEN:**
~ Slide to left to open the disc door.

LOCATION OF CONTROLS

Right Side

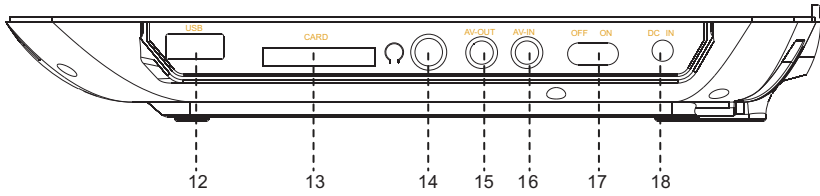

12. USB port

13. Card slot (For SD/MMC Card)

14. Headphone jack

15. AV-OUT jack

16. AV-IN jack

17. Power ON/OFF switch

18. DC IN jack

Front

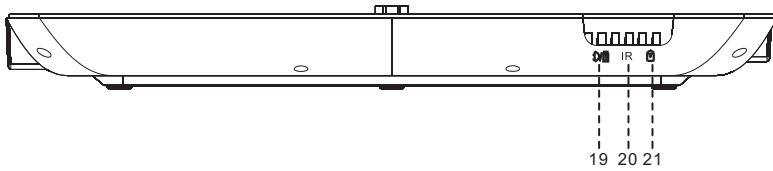

19. Power ON indicator

20. Remote sensor

21. Charging indicator

LOCATION OF CONTROLS (REMOTE CONTROL)

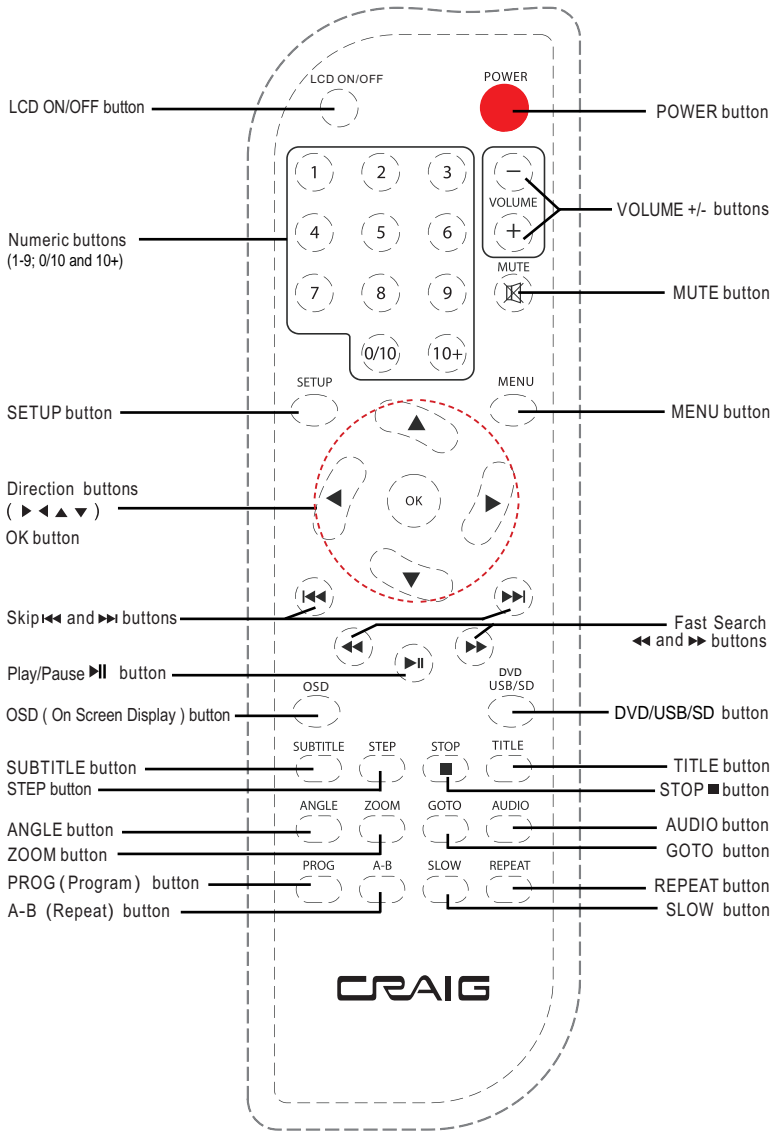

BATTERY INSTALLATION (REMOTE CONTROL)

Battery installation:

1. Press the tabs on the battery door and lifting it off.
2. Install two (2) x AAA size batteries (included) into the battery compartment as the figure on the right and the polarity markings inside battery compartment.
3. Replace the battery door.

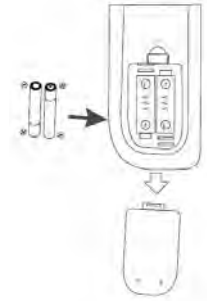

BATTERY PRECAUTIONS:

Follow these precautions when using a battery in this device:

1. Use only the size and type of battery specified.
2. Be sure to follow the correct polarity when installing the battery as indicated in the battery compartment.
A reversed battery may cause damage to the device.
3. Do not mix different types of batteries together (e.g. Alkaline and Carbon-zinc) or old batteries with fresh ones.
4. If the batteries in the device are consumed or the device is not to be used for a long period of time, remove the batteries to prevent damage or injury from possible battery leakage.
5. Do not try to recharge the battery not intended to be recharged; it can overheat and rupture. (Follow battery manufacturer's directions.)
6. Do not dispose of battery in fire. Battery may explodes or leak.
7. Clean the battery contacts and also those of the device prior to battery installation.

BATTERY DISPOSAL WARNING!

To reduce the risk of fire or burns:
Do not disassemble, crush, puncture, or short external connectors contacts.
Use only with specified charger and player.
Do not dispose of in fire or water.
Do not dispose to high temperature above 60°C (140°F).
Store between 0°C (32°F) and 60°C (140°F).

Keep away from children.
See operating instructions of this battery or product.



Li-ion Battery
Must Be Disposed
Of Properly



Batteries should be recycled or disposed of as per State and Local guidelines.

Remote Control sensor

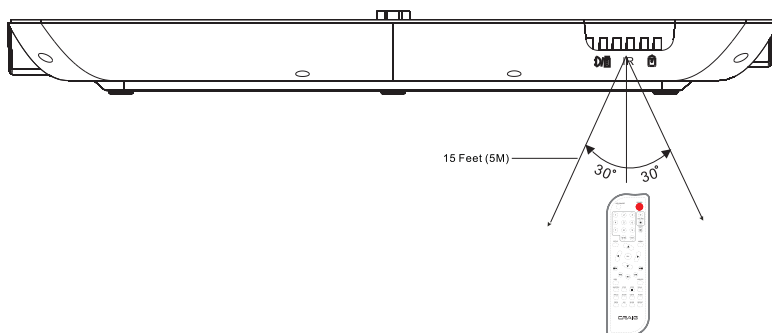

Remarks:

1. When there is an obstacle between the unit and the transmitter, the transmitter may not operate.
2. When direct sunlight, an incandescent lamp, fluorescent lamp or any other strong light shines on the remote sensor of the unit, the remote operation may be unstable.

POWER SOURCE

The unit has a built-in rechargeable Li-polymer battery, recharge it before use as below:

- ~ Insert the small plug from the AC/DC adapter into the DC IN jack on the side of the unit.
- ~ Insert the AC/DC adapter into a conveniently located AC outlet having AC 100-240V~; 50 or 60Hz. Charging will start automatically. During charging, the Red charging indicator will light. When finished, the indicator will turn off.

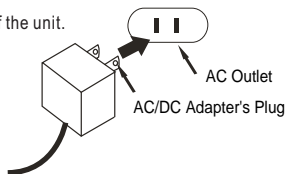

NOTES:

- ~ Use the enclosed AC/DC adapter for this product only.
- ~ Remove the AC/DC adapter from all outlet when not using a long period of time.
- ~ Insert the AC/DC adapter into the wall outlet in vertical and horizontal direction only.

BATTERY INDICATOR

When power of the built-in battery is low, the player will stop and turn off. recharge it as previous procedures. During charging, you can plays the DVD as usual.

NOTES:

- ~ Your battery will last longer if you following these simple guidelines for caring for and storing it.
 - A. For charging first time, charge it at least 10 hours.
 - B. Recharge and store the battery within the temperature range of 5°C~35°C (40°F~95°F).
 - C. Do not over charge (longer than 24 hours). Excessive charging or discharging may shorten the battery's life.
 - D. Battery life naturally shortens slowly over time.
 - E. The rechargeable battery incorporated in this product is not user replaceable.

CONNECTIONS

1. Connect the external TV to the unit through the AV-OUT jack as the Figure 1 below.
2. Connect the external Video Player such like DVD Player, VCR, VDR to the unit through the AV IN jack as the Figure 2 below.
3. After connected, press the SOURCE button on the unit repeatedly to select the AV in or out modes as the connecting.

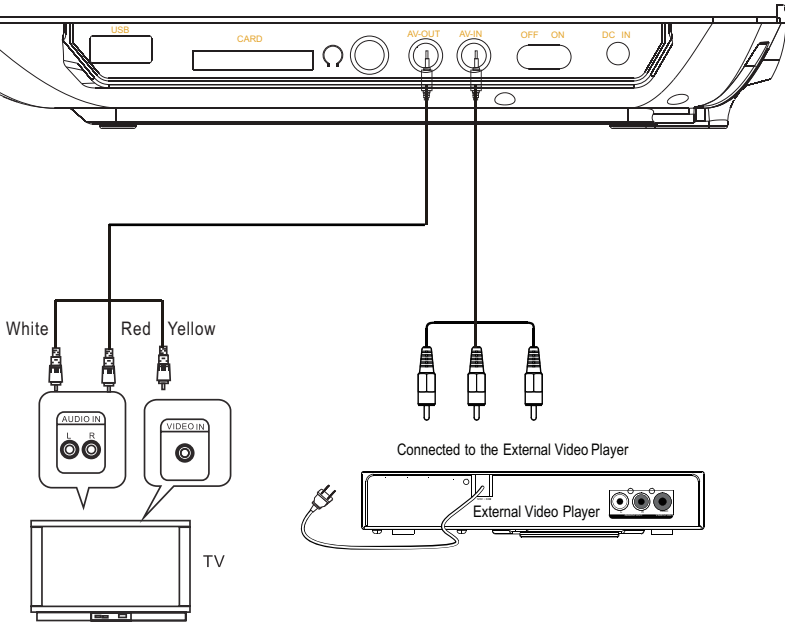

Figure 1

Figure 2

🎧 HEADPHONE:

For private listening, connect the supplied Earbuds into the 🎧 Headphone jack on the side of unit. The speakers will be disconnected when Earbuds are inserted into the jack.

SWIVEL PANEL

The viewing angle of the swivel panel can adjust as below as desired:

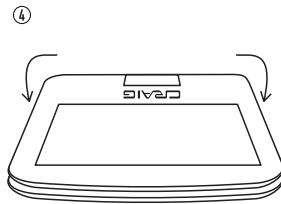
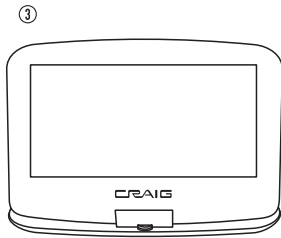
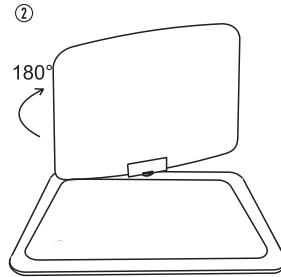
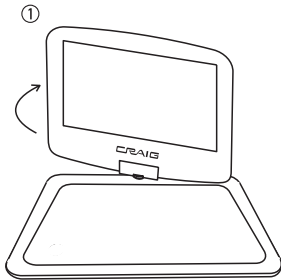

BASIC OPERATION

Disc Playback:

- ~ Lift up the panel and turn to desired angle. Slide the Power ON/OFF switch to "ON" position to power on the player, the Green indicator on front of the player will light.
- ~ Slide the OPEN switch on the disc door to left to open it. Place the disc on the center spindle with label side facing up. Close the disc door and the player will start playback automatically.
- ~ To power off, press the POWER button on the remote control to turn the player to standby mode. The Green indicator will remain lighting. Press the POWER button again to turn the player on from standby mode. (For saving battery power, always power off the player by slide the Power ON/OFF switch on the side of player to OFF position.)

PROG (Program)

- During DVD playback, press the PROG (Program) button. The setting menu will appear on the screen as Fig. A.
- ~ Using the Numeric and Direction buttons to enter the desired Chapter and Title number. Fig.B will appear on the screen. Repeat the same procedures until all the desired Title/Chapters were listed in the list.
- ~ Using the Direction buttons to select and highlight the "Start" button then press the OK button to start program playback.
- ~ During playback, press the Stop ■ button twice to cancel the program playback.

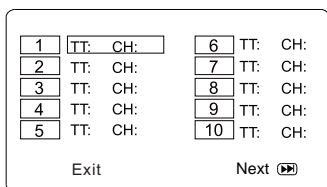

Fig.A

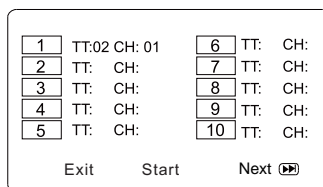

Fig.B

During CD disc playback, press the PROG button, the setting menu will appear on the screen as Fig. C:

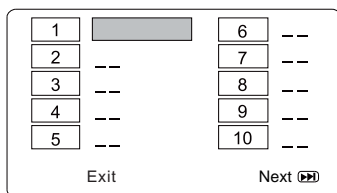

Fig.C

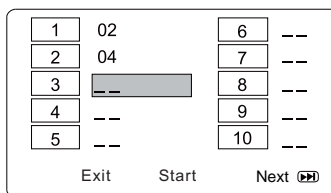

Fig.D

- ~ Using the Numeric and Direction buttons to enter the desired Track number, Fig. D will appear on the screen. Repeat the same procedures until all the desired tracks were listed in the list.
- ~ Using the Direction buttons to select and highlight the "Start" button, then press the OK button to start program playback.
- ~ During playback, press the Stop ■ button twice to cancel the program playback.

NOTE: Program is not functioning in MP3, USB, SD/MMC Card playback modes.

CONTROLS

POWER ON/OFF switch

- Slide the Power ON/OFF switch on the unit to "ON" position to turn on the unit.
Slide the Power ON/OFF switch to "OFF" position to turn off the unit.
(To save the battery power, always power off the unit by sliding it to "OFF" position.)

POWER

- In power on mode, press the POWER button on the remote control to turn it off (Standby mode).
Press again to turn it on.

ZOOM

- During DVD disc playback, press repeatedly to zoom in/out as below:

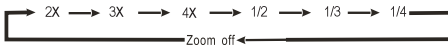

In the zoom mode, press the Direction ▲, ▼, ◀, ▶ buttons to move the position of picture as desire.

A-B

- During playback, press the A-B (Repeat) button to select point A.
- Press it again to select point B. The player will play the section from A to B automatically and repeatedly until the A-B button was pressed.

- ▶● During playback, press to pause.

Press again to resume normal playback.

- ▶● During playback, press the button repeatedly to select the search speed and searching the specific section forward as below:

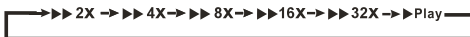

- During searching, press the Play/Pause ▶|| button resume to normal playback.

- ◀● During playback, press the button repeatedly to select the search speed and searching the specific section backward as below:

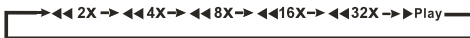

- During searching, press the Play/Pause ▶|| button resume to normal playback.

- ◀● Press repeatedly to skip to previous chapters/tracks as desired.

- ▶● Press repeatedly to skip to next chapters/tracks as desired.

■ STOP

- During playback, press once to pre-stop (In this mode, when press the Play/Pause ▶|| button again. The player will start to play the point your were stopped).
- Or, press twice to stop playback completely (In this mode, when press the Play/Pause ▶|| button again. The player will start to play the current disc from beginning).

Volume +/-

- Press Volume + button to increase volume level.
- Press Volume - button to decrease volume level.

ANGLE

- During DVD playback, press repeatedly to select the available angle as desired.

NOTE: Function depends on the recording of the DVD disc, not all the DVD discs with this function.

CONTROLS

SUBTITLE

- During DVD playback, press repeatedly to select the available subtitles on the DVD as desired.
NOTE: Function depends on the recording of the DVD disc, not all the DVD discs with this function.







MUTE

- During playback, press to turn off the sound temporary, press again to resume.

TITLE

- During DVD playback, press to return to Title menu.
NOTE: Function depends on the recording of the DVD disc, not all the DVD discs with this function.

REPEAT

- During CD playback, press repeatedly to select the repeat mode to  Track (Plays the current track repeatedly) or  All (Plays all tracks repeatedly) as desired.
- During DVD playback, press repeatedly to select the repeat mode to  Chapter (Plays all the titles in the current chapter repeatedly);  Title (Plays the current title repeatedly) or  All (Plays all tracks on the current disc repeatedly).
- To cancel, press the button repeatedly until all repeat icons disappear on the screen or press the Stop  button twice to stop.
- During MP3 disc playback, press repeatedly to select the repeat mode:
 - ~ Random: Press REPEAT Button once to play the files randomly. "Random" will appear on screen.
 - ~ Single: Press REPEAT Button twice to play the current file then stop. "Single" will appear on screen.
 - ~ Repeat One: Press REPEAT Button three times to play the current file repeatedly. "Repeat One" will appear on screen.
 - ~ Repeat Folder: Press REPEAT Button four times to play all the files in the current folder repeatedly. "Repeat Folder" will appear on screen.
 - ~ Normal: Press REPEAT Button five times to return to normal playback mode. "Normal" will appear on screen.

1-9; 10/0 and 10+ buttons

- Enter the desired number in the setting menu or in tracks searching mode.
Remark: ~ "10+" button is valid only in DVD playback mode, e.g. to select chapter "13", press the "10+" and "3" button.
~ In CD/DVD playback mode, press the "0/10" button once to plays the number 10 chapter/tracks directly.

MENU

- During DVD playback, press to return to disc menu.

GOTO

In DVD Playback:

- To select the desired Title and Chapter, press the GOTO button once, the Title and Chapter selection menu will appear on the screen. Use the Direction and Numeric buttons to select the desired title and chapter then press the OK button to start playback.
- Select the desired establish time of the current Title to play, press the GOTO button twice, the time selection table will appear on the screen. Using the Direction and Numeric buttons to enter the desired establish time. The unit will start plays the movie from the selected establish time.
- Select the desired establish time of the current Chapter to play, press the GOTO button three times, the time selection table will appear on the screen. Using the Direction and Numeric buttons to enter the desired establish time. The unit will start plays the movie from the selected establish time.

In CD or MP3 playback:

- Press the GOTO button then select and plays the desired track as the on screen instructions.

CONTROLS

SLOW

- During playback, press the SLOW button repeatedly to set and plays the video in slow motion as desire.
Press the Play/Pause ►|| button to resume to normal playback.

DVD/USB/SD

- If USB device and/or SD/MMC memory card was inserted, press the button repeatedly to select the playback source to DVD (For disc playback); USB (Plays the files inUSB device) or Card (Plays the files in the SD or MMC card) as desire.

OK

- Press to confirm the selection.

DIRECTION (► ◀ ▲ ▼)

- Press to moving the cursor in the setting menu.

SETUP

- Press to enter or exit setting menu.

OSD (On Screen Display)

- During playback, press repeatedly to display the playback conditions on screen.

AUDIO

- During DVD playback, press repeatedly to select the available language or audio channel in the disc.
Note: Function depends on the record of the disc.

STEP

- During DVD playback, press repeatedly to move forward frame by frame, press the Play/Pause ►|| button to resume normal playback.

LCD ON/OFF

- Press to turn on/off the display.

SYSTEM SETUP

Setting Menu:

Press the SETUP button, the setting menu will appear on the screen as below. Using the Direction ▲, ▼, ◀, ▶ buttons to select and highlight the function you need to set or reset. Press the OK button to enter or confirmed the selection. After setting, press the SETUP button to save the settings and exit.

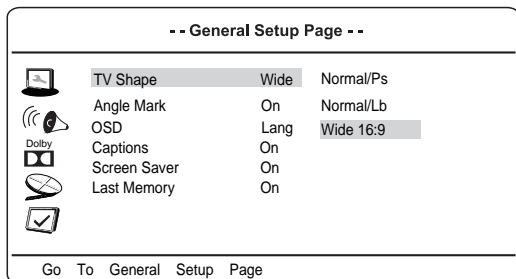

GENERAL SETUP

1. If TV Shape is selected, using the Direction and OK buttons to set the aspect ratio to match the playing movie.
2. If Angle Mark is selected, using the Direction and OK buttons to set it On or Off. If set to On, when multi-angles are available on the playing DVD, the multi-angle logo will appear on the screen.
3. If OSD Lang (On Screen Display Language) is selected, using the Direction and OK buttons to set the OSD language as desired.
4. If Captions is selected, using the Direction and OK buttons to set it On or Off. If set to On, when captions available on the playing DVD, it will show on the screen automatically.
5. If Screen saver is selected, using the Direction and OK buttons to set it On or Off. If set to On, the screen saver will come on when the unit stops or the image is paused for approximately five minutes.
6. If Last Memory is selected, using the Direction and OK buttons to set it On or Off. If set to On, the unit will start playback from the position where the disc was stopped last time.

SPEAKER SETUP

If Speaker Setup is selected, press the OK button to enter. Downmix setting menu will appear, using the Direction and OK buttons to set it to Lt /Rt or Stereo.

~If set to LT/RT, the rear left or rear right channels will play on both Left and Right Speakers.

~If set to Stereo, the rear left channel will play on the Left Speaker; the rear right channel will play on Right Speaker.

DOLBY DIGITAL SETUP

1. If Dual Mono is selected, using the Direction and OK buttons to set it to Stereo, L-Mono (Play Left channel on all speakers), R-Mono (Play Right channel on all speakers) or Mix-Mono (Mixed Right and Left channel then plays on all speakers) as desired. (Functions depend on the recording of the disc).
2. If Dynamic is selected, using Direction and OK buttons to set the dynamic level as desired or turn it off.

SYSTEM SETUP

VIDEO SETUP

1. If the Picture is selected, using the Direction and OK buttons to set the panel quality of screen such like Sharpness, Brightness, Contrast, Hue and Saturation.
2. If Panel Ratio is selected, using the Direction and OK button to set the aspect ratio of the panel to 16:9 or 4:3 to match the aspect ratio of playing movie.

PREFERENCE SETUP

The preference page can be selected in disc stop playing mode only.

1. If TV Type is selected, using the Direction and OK buttons to set to PAL, AUTO or NTSC to match the color system of the TV. (Note: The TV system in US, Canada and Mexico is NTSC.)
2. If Audio, Subtitle or Disc Menu is selected, using the Direction and OK buttons to set the priority of the available language. (Functions depend on the recording of DVD.)
3. If Parental is selected, using the Direction and OK buttons to set the rating level as desired as follow:
 - ~ Press the Direction ► button to enter, the rating level list will appear.
 - ~ Press the Direction ▲ or ▼ button to select the desired level.
 - ~ Press the OK button to enter, password enter window will pop up.
 - ~ Enter the four digit password (default password is 7510) by pressing the Numeric buttons.
 - ~ Press the OK button to save the settings and exit.
 - ~ Rating levels:
 1. (Kid Saf): Kid safe
 2. (G): All ages
 3. (Pg):Parental Guidance
 4. (Pg 13):Parental Guidance less than 13 years old
 5. (Pgr): under 17 years old, Parental Guidance suggested
 6. (R): Under 17 years old, Parental Guidance strongly
 7. (Nc 17): 17 years old and above
 8. (Adult): Adult only
4. If Password is selected, press the OK button to enter. The sub setting menu will appear.
 - ~ If Password Mode is selected, using the Direction and OK buttons to set it ON (activate the rating level setting) or OFF (Password is needed).
 - ~ If Password is selected, press the OK button twice to enter, the sub setting menu will appear.
 1. Enter the four digit old password. The column of New Password will be highlighted.
 2. Enter the new four digit password. The column of Confirm Pwd will be highlighted.
 3. Enter the new password again. OK button on the screen will highlighted. Press the OK button to save the setting and exit.
5. If Default is selected, using the Direction and OK buttons to reset all settings to default setting or press the SETUP button to exit without changes.

USB OR SD/MMC CARD PLAYBACK

1. Insert the USB Device or SD/MMC memory card (not included) into the USB port/card slot as the figure below:

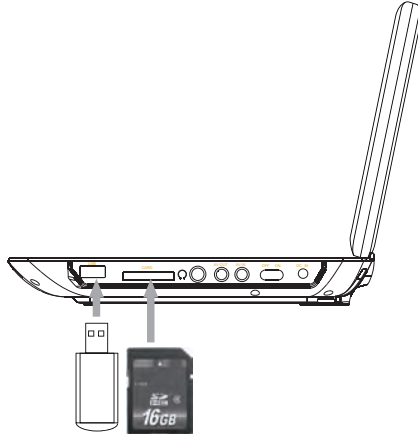

NB: The unit supported to playback:

~ MP3; WMA (Music file)

~ JPG (Pictures)

~ AVI; VOB (Video files up to 640x480 pixels)

Make sure correct files were saved in the USB device or memory cards before insert to the unit.

2. Power on the unit, press the DVD/USB/SD button repeatedly to select the desired playback source.

Wait until folder/file list appear on the screen. Using the Direction buttons to selected the desired file, then press OK button to start playback.

3. Others operations are similar to DVD playback.

TROUBLESHOOTING

No power

Power of built-in battery may consumed. Recharge it by the supplied AC/DC Adaptor. During charging, the unit can plays disc at the same time.

No sound

~ Volume level too low. Rising it by press the VOL (Volume) + button.

Remote control not functioning

- ~ The battery is consumed, replace by new one .
- ~ Point the remote control to the remote sensor on the unit.
- ~ Remove the obstacles between the remote control and remote sensor.

Forgotten the preset rating password.

If the password was forgotten, used the default password 7510 to release the lock and reset a new password.

CARE AND MAINTENANCE

Caring for Discs

- Treat the disc carefully. Handle the disc only by its edges. Never allow your fingers to contact with the shiny, unprinted side of the disc.

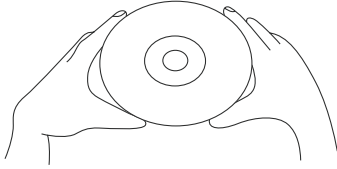

- Do not attach adhesive tape, stickers, etc. to the disc label.
- Clean the disc periodically with a soft, lint-free, dry cloth. Never use detergents or abrasive cleaners to clean the disc. If necessary, use a CD cleaning kit.
- If a disc skips or gets stuck on a section of the disc, it is probably dirty or damaged (scratched).
- When cleaning the disc, wipe in straight lines from the center of the disc to the outer edge of the disc. Never wipe in circular motions.

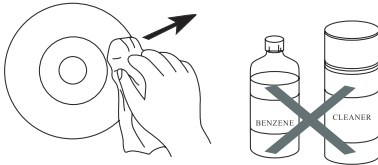

- Discs should be stored in their cases after each use to avoid damage.
- Do not expose discs to direct sunlight, high temperatures or dust, etc. Prolonged exposure or extreme temperatures can warp the disc.
- Do not stick or write anything on either side of the disc. Sharp writing instruments, or the ink, may damage the surface.

Cleaning the Unit

- To prevent fire or shock hazard, disconnect your unit from the AC power source when cleaning.
- The finish on your unit may be cleaned with a dust cloth and cared for as other furniture. Use caution when cleaning and wiping the plastic parts.
- Mild soap and a damp cloth may be used on the front panel.

SPECIFICATIONS

Power Source:

Main Unit

Built-in DC \equiv 7.4V, Li-polymer battery;
Recharge by DC \equiv 12V, 1A \ominus \oplus

Supplied AC/DC Adaptor

Input: AC 100-240V~, 50/60Hz, 0.5A

Output: DC \equiv 12V, 1A \ominus \oplus

Remote Control

DC \equiv 3V, 2 x "AAA" size batteries, included

Power Consumption:

12W (Max)

Color system:

NTSC/PAL

Discs played:

(1) DVD-VIDEO disc

12cm single-sided, single-layer
12cm single-sided, dual-layer
12cm double-sided, single-layer
8 cm single-sided, single-layer
8 cm single-sided, dual-layer
8 cm double-sided, single-layer

(2) Compact disc

12cm disc
8 cm disc

Video output level:

1 Vp-p

Audio output level:

1.5Vrms (1 KHz, 0dB)

Audio signal output characteristics:

Frequency responses:

DVD (linear audio):

20Hz-20KHz (48KHz sampling)

20Hz-20KHz (96KHz sampling)

CD audio:

20Hz-20KHz

S/N ratio:

70dB

Pickup:

Wave length:

DVD640 \pm 10nm, CD790 \pm 15nm

Laser power:

CLASS 1

ACCESSORIES

- Remote control, uses 2 x AAA size batteries (included) x 1
- Audio / Video connection cable x 1
- Earbuds x 2
- AC/DC Adapter x 1
- User's Manual x 1
- Audio Splitter x 1
- Carrying Case x 1

SPECIFICATIONS ARE SUBJECT TO CHANGE WITHOUT NOTICE

LIMITED WARRANTY

Craig warrants this product to be free from manufacturing defects in material and workmanship under normal use for a period of 90 days from date of purchase. If service is required, please return the product to the store where it was purchased for exchange; or, pack the unit in the original packing material with all accessories if applicable, a copy of your sales receipt and a Cashier's check or Money Order for \$20.00 (to cover shipping and handling costs) payable to Craig Electronics Inc. For consumers in Canada, please make sure that the cashier check or money order is redeemable through a U.S. bank. Ship your product freight pre-paid. Your unit will be repaired, replaced or if the unit can not be repaired or replaced, a refund will be forwarded to you within four weeks of receipt of your unit. Please ship your unit to:

Craig Electronics Inc.
1160 NW 163 Drive
Miami, FL 33169

This warranty is void if the product has been: a) Used in a commercial application or rental. b) Damaged through misuse, negligence, or abuse. c) Modified or repaired by anyone other than an authorized Craig service center. d) Damaged because it is improperly connected to any other equipment.

Note: This warranty does not cover: a) Ordinary adjustments as outlined in the Owner's Manual which can be performed by the customer. b) Damage to equipment not properly connected to the product. c) Any cost incurred in shipping the product for repair. d) Damage to the product not used in the USA.

This warranty is not transferable and only applies to the original purchase. Any implied warranties, including the warranty of merchantability, are limited in duration to the period of this expressed warranty and no warranty whether expressed or implied shall apply to the product thereafter.

Under no circumstance shall Craig be liable for any loss or consequential damage arising out of the use of this product. This warranty gives specific legal rights. However, you may have other rights which may vary from state to state. Some states do not allow limitations on implied warranties or exclusion of consequential damage. Therefore, these restrictions may not apply to you.

To Obtain Service on your Product
email: service@craigelectronics.com