

ASSEMBLY INSTRUCTIONS

FLEXION[®]

CARE INSTRUCTIONS:

- Clean with water and mild detergent.
Allow to dry thoroughly before storing.

FIRE AND SAFETY PRECAUTIONS:

- Always ensure the gazebo is firmly secured to the ground before use.
- Always use external tie-downs and stakes to secure your gazebo.
- This gazebo is designed for temporary use only and not as a permanent structure.
- Never leave the gazebo unattended when raining or during windy conditions.
- Do not allow water to collect on the canopy, as this may cause the structure to collapse.
- Do not smoke in or near the gazebo.
- Do not place hot appliances in or around the gazebo.
- Do not use open flame heaters in your gazebo.
- Fabric will melt when contact is made with hot surfaces.

WARNING: The UV50+ rating is for the canopy material only. The amount of sun protection received will vary depending on the correct positioning of the gazebo. Please note the suggested positioning. Reflective rays can also cause sunburn. Sunscreen should be worn at all times.

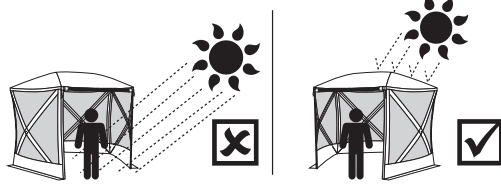

**2 PERSON
ASSEMBLY**

WARNING:
KEEP ALL FLAME & HEAT SOURCES AWAY FROM THIS TENT FABRIC.

This tent is made with fabric that meets CPAI-84 specifications for flame resistance. It is not fire proof. The fabric will burn if left in continuous contact with any flame source. The application of any foreign substance to the tent fabric may render the flame-resistant properties ineffective.

SlumberTrek[®] Inc.

This SlumberTrek product is designed in Australia and Made in China. Flexion[®] is a registered trademark of SlumberTrek Australia Pty. Ltd.
c/o Team 80
5500 Greenwood Plaza Blvd Ste 130
Greenwood Village CO 80111
www.slumbertrek.com

Customer service:
salessupport@slumbertrek.com.au

PARTS

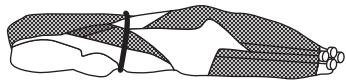

FLEXION GAZEBO x 1



ROOF POLES x 3



DOOR POLES x 3

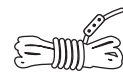

GUY ROPES x 6

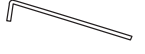

GROUND PEGS x 11

SETUP

NOTE: UNPACK IN AN OPEN AREA ENSURING THERE ARE NO SHARP OBJECTS IN THE VICINITY AS THEY MAY DAMAGE FABRIC. AVOID SETTING UP ON CONCRETE OR HARD SURFACES AS ABRASION CAN DAMAGE THE FABRIC.

1 FOLD OUT THE GAZEBO AND LAY OUT THE WALLS.

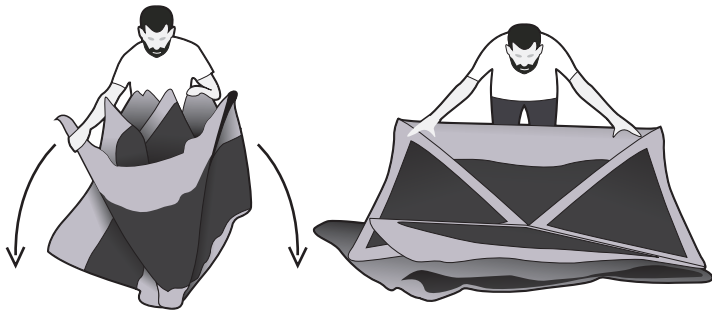

2 POP-OUT THE GAZEBO WALLS X 4.

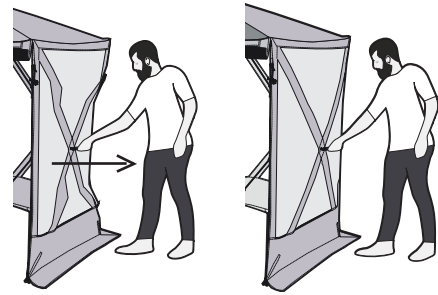

3 INSERT THE POLES INTO THE DOOR AND ROOF.

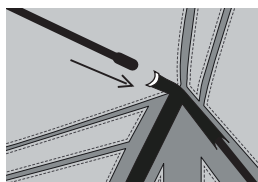

4 PEG DOWN THE GAZEBO AT THE BASE OF EACH CORNER. USE GUY ROPES, PEGS AND SAND POCKETS TO SECURE FIRMLY.

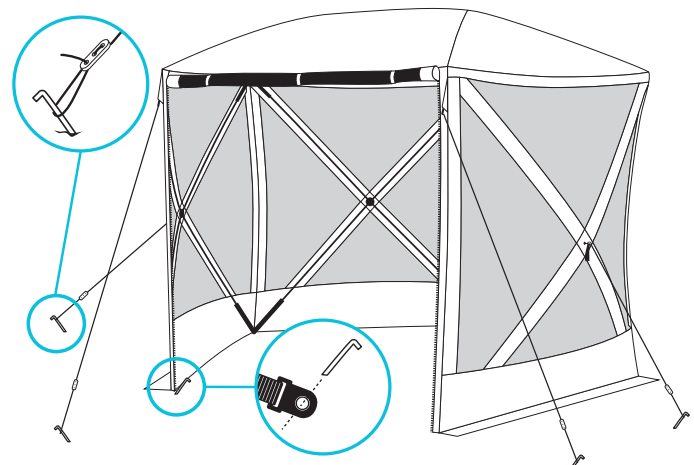

PACK DOWN

REVERSE THE ABOVE SETUP INSTRUCTIONS TO PACK DOWN THE GAZEBO.