

# Owner's guide

NV352Q



# Shark®

# IMPORTANT SAFETY INSTRUCTIONS

## For Household Use Only

**WHEN USING AN ELECTRICAL APPLIANCE, BASIC SAFETY PRECAUTIONS SHOULD ALWAYS BE OBSERVED, INCLUDING THE FOLLOWING:**

**READ ALL INSTRUCTIONS BEFORE USING YOUR SHARK® NAVIGATOR™ LIFT-AWAY®.**

### **POLARIZED PLUG:**

To reduce the risk of electric shock, this appliance has a polarized plug (one blade is wider than the other). As a safety feature, this plug will fit into a polarized outlet only one way. If the plug does not fit fully into the outlet, reverse the plug. If it still does not fit, contact a qualified electrician.

**DO NOT force into outlet or try to modify to fit.**

**⚠ WARNING:** To reduce the risk of electric shock or injury, do not use outdoors or on wet surfaces.

## **WARNING:**

**TO REDUCE THE RISK OF FIRE, ELECTRIC SHOCK OR INJURY:**

### **GENERAL ELECTRICAL SAFETY:**

1. Unplug from electrical outlet when not in use and before servicing.
2. **DO NOT** use vacuum with a damaged cord or plug. If appliance is not working as it should, has been dropped, damaged, left outdoors, or dropped into water, return it to EURO-PRO Operating LLC for examination, repair, or adjustment.
3. **DO NOT** pull or carry vacuum by the cord.
4. **DO NOT** unplug by pulling on cord; to unplug, grasp the plug, not the cord.
5. **DO NOT** handle plug or appliance with wet hands.
6. **DO NOT** run the vacuum over the power cord.
7. **DO NOT** use the cord as a handle.
8. **DO NOT** close a door on the cord.
9. **DO NOT** pull cord around sharp corners. The use of an extension cord is not recommended.
10. **DO NOT** leave appliance when plugged in.
11. Keep cord away from heated surfaces.
12. Turn off all controls before plugging or unplugging vacuum cleaner.
13. Always turn off this appliance before connecting or disconnecting motorized nozzle.
14. Store your appliance with the power cord secured around the two cord holders-as shown in the storage instructions.

## HOSE ATTACHMENTS:

1. **DO NOT** use if air flow is restricted; if the air paths, the hose, or the accessories become blocked, turn the vacuum cleaner off. Remove all obstructions before you turn on the unit again.
2. Keep the end of the hose and accessory openings away from face and body.
3. Keep cleaning tools and hose suction openings away from hair, face, fingers, uncovered feet, or loose clothing.
4. Only use manufacturer's recommended attachments.

## GENERAL USE:

1. Use only as described in this manual.
2. **DO NOT** put any objects into openings. **DO NOT** use with any opening blocked; keep free of dust, lint, hair, and anything that may reduce air flow.
3. Keep your work area well lit.
4. Keep the vacuum moving over the carpet surface at all times to avoid damaging the carpet fibers.
5. **DO NOT** place vacuum on unstable surfaces such as chairs or tables.
6. **DO NOT** allow young children to operate the vacuum or use as a toy. Close attention is necessary when used by or near children.
7. **DO NOT** use vacuum cleaner if it has been dropped, damaged, left outdoors, or submerged in water. Return to EURO-PRO Operating LLC for examination, repair, or adjustment.
8. **DO NOT** use without dust cup and/or filters in place.

## DUST CUP/FILTERS/ACCESSORIES:

Before turning on the vacuum:

1. Make sure that all filters are thoroughly dry after routine cleaning.
2. Make sure that dust cup and all filters are in place after routine maintenance.
3. Make sure accessories are free of blockages.
4. Only use filters and accessories provided by EURO-PRO Operating LLC. [Failure to do so will void the warranty.]

## GENERAL CLEANING:

1. **DO NOT** pick up large-sized objects.
2. **DO NOT** pick up hard or sharp objects such as glass, nails, screws or coins that could damage the vacuum cleaner.
3. **DO NOT** pick up smoking or burning objects such as hot coals, cigarette butts, or matches.
4. **DO NOT** pick up flammable or combustible materials such as lighter fluid, gasoline, or kerosene or use vacuum in areas where they may be present.
5. **DO NOT** pick up toxic solutions such as chlorine bleach, ammonia, or drain cleaner.
6. **DO NOT** use in an enclosed space where vapors are present from paint, paint thinner, moth-proofing substances, flammable dust or other explosive or toxic materials.
7. **DO NOT** vacuum up any liquids.
8. **DO NOT** immerse vacuum cleaner in water or other liquids.
9. **DO NOT** use outdoors or on wet surfaces; use only on dry surfaces.
10. Use extra care when cleaning on stairs.

# SAVE THESE INSTRUCTIONS

**This manual covers model number:**

NV352Q 31

**TECHNICAL SPECIFICATIONS**

Voltage: 120V., 60Hz

Watts: 1200W

Amps: 10A

# Contents

Thank you for  
purchasing  
the **Shark®**  
**Navigator™**  
**Lift-Away®**.

<b>Getting Started</b>	<b>6</b>
<b>Mode 1: Upright Vac</b>	<b>8</b>
<b>Mode 2: Detachable Canister</b>	<b>10</b>
<b>Above-Floor Cleaning</b>	<b>11</b>
<b>Storing</b>	<b>12</b>
<b>Maintenance</b>	<b>12</b>
<b>Emptying the Dust Cup</b>	<b>13</b>
<b>Cleaning the Pre-Motor Filters</b>	<b>13</b>
<b>Cleaning the Post-Motor HEPA Filter</b>	<b>14</b>
<b>Cleaning the Turbo Brush</b>	<b>14</b>
<b>Cleaning the Motorized Floor Brush</b>	<b>15</b>
<b>Checking for Blockages</b>	<b>15</b>
<b>Ordering Parts</b>	<b>16</b>
<b>Troubleshooting Guide</b>	<b>17</b>
<b>Warranty</b>	<b>18</b>

# Getting Started

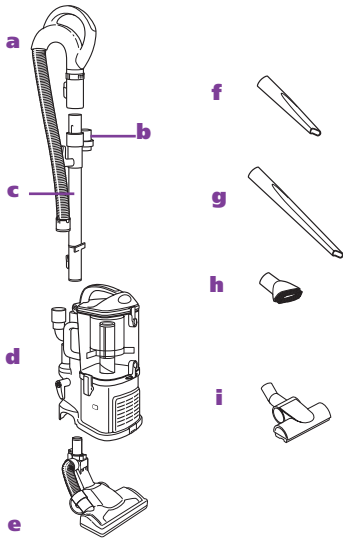

## FIRST THING'S FIRST, YOU NEED TO KNOW WHAT'S IN THE BOX YOU JUST OPENED:

- a** Handle with Stretch Hose
- b** Accessory Holder
- c** Extension Wand
- d** Detachable Canister
- e** Motorized Floor Brush Nozzle
- f** Crevice Tool
- g** 24" Crevice Tool
- h** Dusting Brush
- i** Turbo Brush

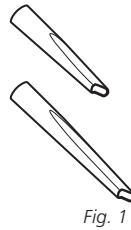

Fig. 1



Fig. 2



Fig. 3

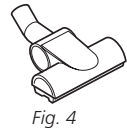

Fig. 4

## ACCESSORIES:

### CREVICE TOOL

Reach deep into narrow spaces and clean between cushions, under radiators and baseboards and in hard to reach crevices and corners. **(Fig. 1)**

### DUSTING BRUSH

Dust shelves, lamp shades, window blinds, books, furniture and other upholstered household items. **(Fig. 2)**

### ACCESSORY HOLDER

Designed to hold the crevice tool and dusting brush. For quick access to tools when vacuuming and cleaning around the house. **(Fig. 3)**

### TURBO BRUSH

This unique tool was engineered for fast and easy removal of pet hair and ground in dirt from carpeted stairs and upholstery. **(Fig. 4)**

Your new *Shark® Navigator™ Lift-Away®* vacuum cleaner can easily be configured into different cleaning modes to meet all your cleaning needs: upright vacuum and detachable canister - both with constant suction power.

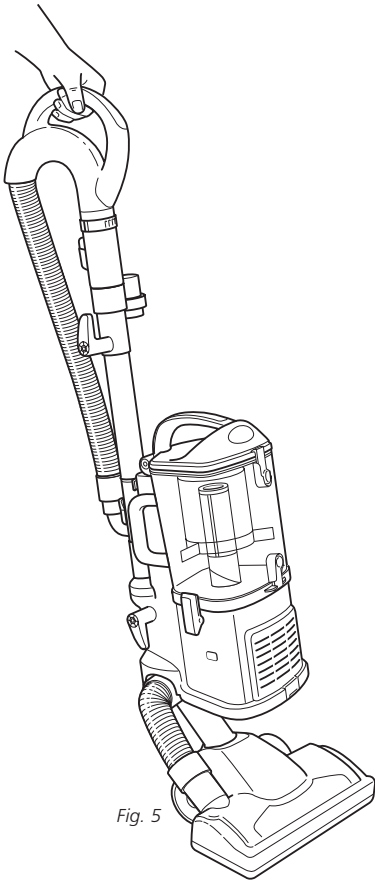

Fig. 5

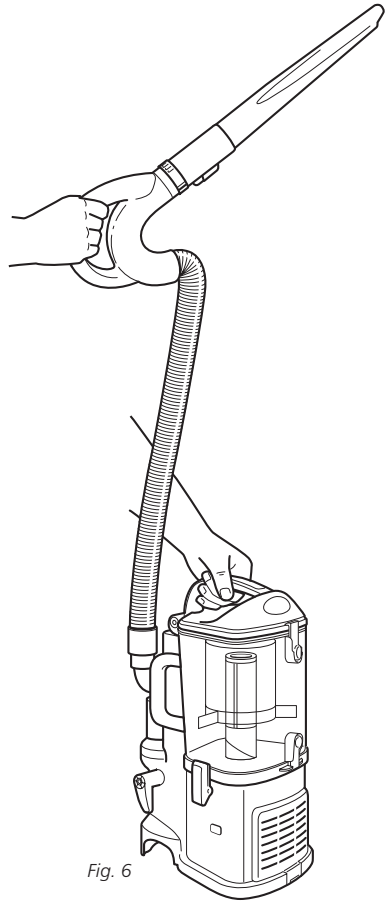

Fig. 6

#### MODES:

##### 1 UPRIGHT VAC

Upright vacuuming - floors and carpets. (Fig. 5)

##### 2 DETACHABLE CANISTER

Take the detachable canister with you around the house to clean all kinds of hard to reach places. (Fig. 6)

# Mode 1: Upright Vac

**!** To reduce the risk of electric shock, unplug the unit before assembling, adding or removing attachments or converting modes.

**!** **WARNING:** The On/Off switch is on the top of the detachable canister. Always ensure the power is OFF ("O" position) before plugging and unplugging.

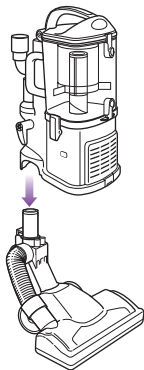

Fig. 7

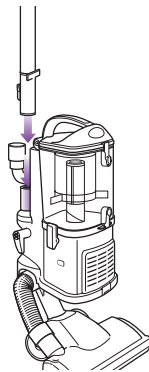

Fig. 8

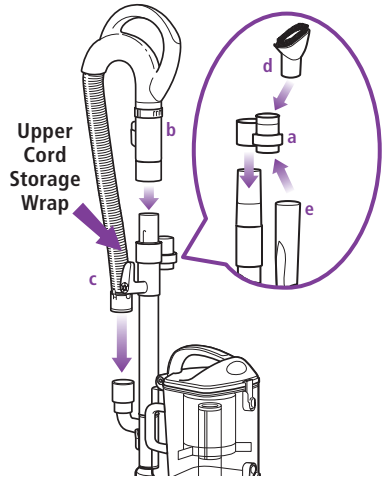

Fig. 9

## TO ASSEMBLE:

- 1 Place the floor nozzle on a level surface.
- 2 Align the tube of the floor nozzle with the tube on the detachable canister and lower until you hear the two pieces click into place. (Fig. 7)

When attaching the motorized floor brush, ensure that the latching mechanism is fully locked in place to ensure electrical connection has been made.

- 3 Attach the end of the extension wand to the tube on the back of the detachable canister until it clicks into place. (Fig. 8)
- 4 Slide the accessory holder (a) positioned opposite the upper cord wrap, over the extension wand. Align the tab with the groove and push down. (Fig. 9)

- 5 Push the handle (b) onto the top of the extension wand until you hear it click into place. (Fig. 9)
- 6 Insert the end of the stretch hose (c) into the connector on the back of the detachable canister. (Fig. 9)
- 7 Store the dusting brush (d) and the crevice tool (e) on the mounts of the accessory holder. (Fig. 9)



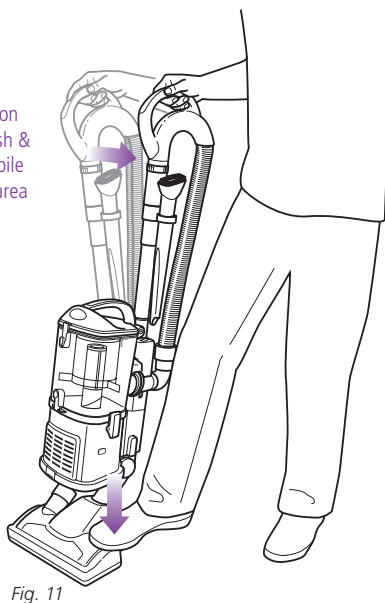
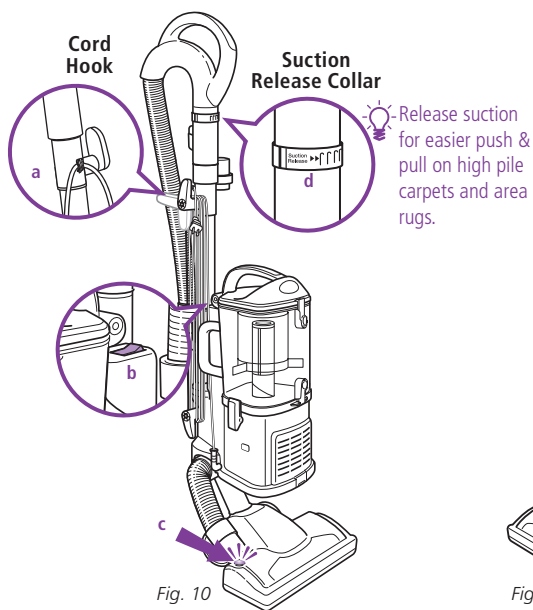

## TO USE:

- 1 Rotate the cord release to quickly release the power cord.
- 2 Secure the power cord in the cord hook (a).



- 3 Press the On/Off switch (b) to the "I" position to vacuum bare floors (straight suction only) or to the "II" position to engage the motorized floor brush (for vacuuming carpets and rugs).

- 4 **IMPORTANT:** The motorized brush indicator light (c) will illuminate green when motorized floor brush is on, or red if there is a blockage or jam.

- 4 Gently press the floor nozzle down with your foot while you grasp the handle and tilt it back towards you.

**NOTE:** The rotating brush on the motorized floor brush will not spin unless the nozzle is flat against the floor and the handle is tilted back.

- 5 Due to the huge suction power of this vacuum, it may become necessary at times to adjust the suction release to open the valve. Rotate the collar clockwise to close the valve when you need high suction and for vacuuming floors.
- 6 Empty dust cup after vacuuming and periodically during use when it appears full. (See "Maintenance" section for instructions.)
- 7 When you are finished vacuuming, turn the vacuum off.

## Mode 2: Detachable Canister

 You can carry your vacuum cleaner in both modes by the carry handle located on top of the dust cup.

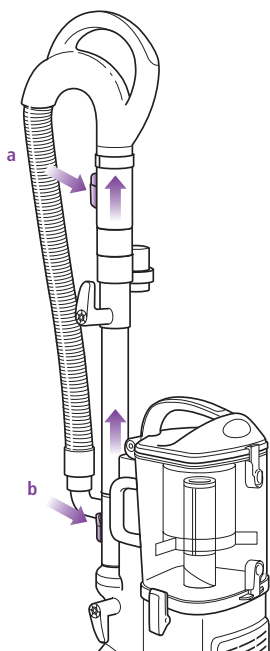

Fig. 12

### LIFT AWAY DETACHABLE CANISTER FOR PORTABLE CLEANING

- 1 Separate the detachable canister from the floor nozzle. (See page 8, Fig. 7.)
- 2 Press the handle release button (a) and pull the handle up or press the extension wand release button (b) and pull the extension wand up. (Fig. 12)

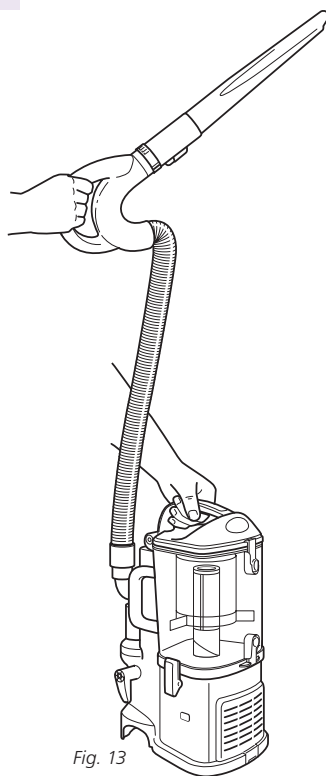
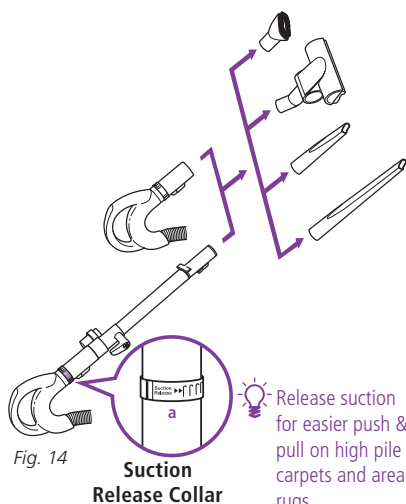

Fig. 13

- 3 Attach desired accessory onto the end of either the extension wand or the handle.
- 4 Press the On/Off switch to the "I" position to turn the vacuum on for above-floor cleaning and hold the handle in one hand while you carry the detachable canister around the house with the other hand. (Fig. 13)

# Above-Floor Cleaning



## CLEAN ABOVE THE FLOOR IN UPRIGHT VAC OR DETACHABLE CANISTER MODE

- 1 Press the handle release button and pull the handle up or press the extension wand release button and pull the extension wand up.
- 2 Attach desired accessory onto the end of either the extension wand or the handle. (Fig. 14)
- 3 **Your vacuum has tremendous suction power. Adjust the amount of suction with the suction release on the handle. Open the valve (a) by rotating the collar 90° counterclockwise for low suction when doing light jobs such as drapes or fine surfaces. Close the valve (a) by rotating the collar clockwise 90° for high suction and when using the hand held turbo brush. (Fig. 14)**

- 4 Press the On/Off switch to the "I" position to turn the vacuum on for above-floor cleaning.

**IMPORTANT:** Ensure vacuum is in upright position. Do not use position "II" when cleaning above the floor in the upright vac mode as this will engage the motorized floor brush. The rotating brush may damage your floor if run for a prolonged period of time in one area.

## Storing

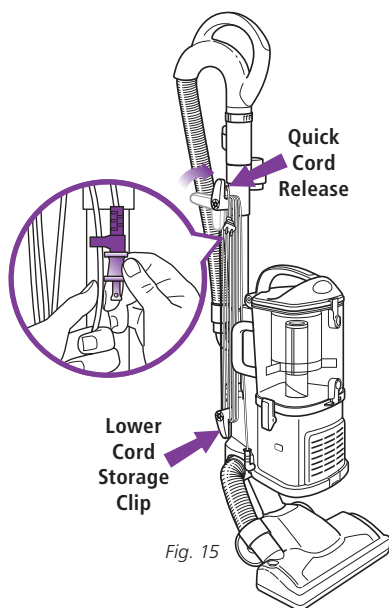

Fig. 15

### STORE YOUR VACUUM SAFELY

- 1 Convert your vacuum back to upright vac mode.
- 2 Rotate the upper quick cord release to its upright position and coil the power cord loosely around the two clips. Clip the plug onto the cord to secure. (Fig. 15)
- 3 Store the dusting brush and the crevice tool on the mounts on the accessory holder.
- 4 Store your vacuum cleaner safely in a cool dry area where it will not be a hazard, will not get damaged and will not cause damage to anyone or anything.

**NOTE:** Empty dust cup after cleaning and prior to storing. (See "Maintenance" section for instructions.)

## Maintenance

- ⚠ To reduce the risk of electric shock, unplug the unit before performing any cleaning, maintenance, or troubleshooting checks.
- ⚠ Reassemble all parts securely before operating vacuum.
- ⚠ **DO NOT** operate the vacuum without the pre-motor filters and dust cup in place.
- ⚠ **DO NOT** operate the vacuum with WET filters.
- ⚠ **IMPORTANT:** Make sure all filters are completely dry before inserting back into vacuum.
- ⚠ **WARNING:** Never insert sharp objects into any opening to clear an obstruction.
- ⚠ **IMPORTANT:** Damages caused while clearing or attempting to clear blockages are not covered under your product's limited warranty.

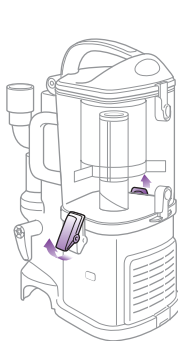

Fig. 16

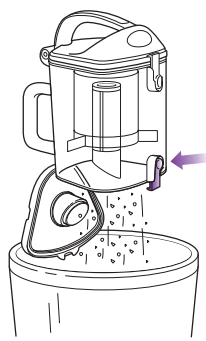

Fig. 17

COMPONENT	MAINTENANCE SCHEDULE
1 Dust Cup	Empty each time you vacuum.
2 Pre-Motor Foam Filter	Rinse and air dry every 3 months under normal use.
3 Pre-Motor Felt Filter	Rinse and air dry every 3 months under normal use.
4 Post-Motor HEPA Filter	Clean once every 2 years or as needed.

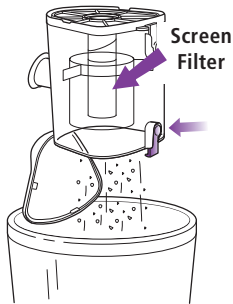

Fig. 18

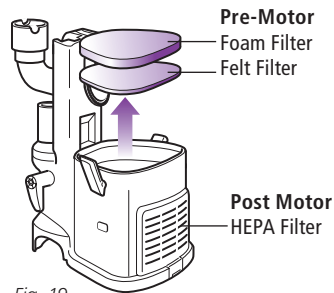

Fig. 19

## EMPTYING THE DUST CUP

The dust cup needs to be emptied each time you vacuum and periodically during cleaning, when the dust cup appears full.

- 1 Undo the latches on the sides of the dust cup by lifting them up and outwards to remove the dust cup from the motor base. (Fig. 16)
- 2 Hold the dust cup over a trash receptacle and press the bottom door release button. (Fig. 17) Tap gently to empty contents. Press the door shut again until it clicks.
- 3 If needed, turn the dust cup upside down over the trash receptacle and press the top door release button. (Fig. 18) Tap gently to remove contents.  
Use a dry cloth or paper towel to remove debris stuck to the screen filter inside the dust cup. Press the door shut again until it clicks.
- 4 Replace the dust cup on top of the motor base. Hook the two latches onto the tabs on the sides of the dust cup and push down to lock.

## CLEANING THE PRE-MOTOR FILTERS

- 1 Remove the dust cup.
  - 2 Pull the 2 filters out from the top of the motor base. (Fig. 19)
  - 3 Rinse the filters thoroughly in lukewarm water until the water runs clear.
- !** **DO NOT** put the filter in the washing machine or dishwasher.
- NOTE:** The material in the filter will discolor over time. This is **NORMAL** and will not affect the performance of the filter.
- 4 Squeeze out excess water and let air-dry for at least 24 hours before replacing. Do not use a hair dryer or other heating methods to dry.
  - 5 Place the felt filter in first, then the foam filter.
  - 6 Replace the dust cup.

## Maintenance - cont'd

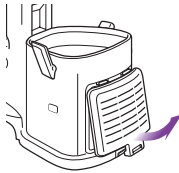

Fig. 20

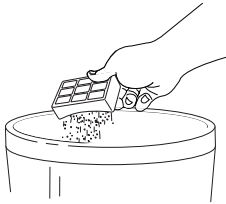

Fig. 21

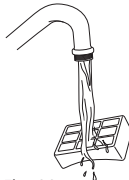

Fig. 22

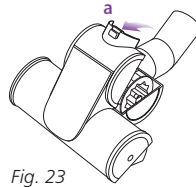

Fig. 23

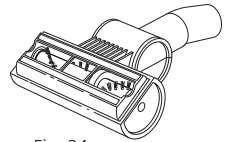

Fig. 24

### CLEANING THE POST-MOTOR HEPA FILTER

- 1 Remove the filter cover from the front of the vacuum by pulling up on the tab and pulling the cover away from the vacuum. (Fig. 20)
- 2 Take out the HEPA filter by pulling it straight out.
- 3 Turn the filter over so that the dirty side is on the bottom and vigorously tap it clean against a garbage can to remove any dust. (Fig. 21)
- 4 Wash the filter under the tap using lukewarm water with the dirty side face down until the water runs clear. (Fig. 22)

**!** **DO NOT** put the filter in the washing machine or dishwasher.

**NOTE:** The material in the filter will discolor over time. This is **NORMAL** and will not affect the performance of the filter.

- 5 Allow the filter to air dry for 24 hours. Do not use a hair dryer or other heating methods to dry.
- 6 Once the HEPA filter is dry, replace it back into the vacuum.
- 7 Replace the cover by inserting the two tabs into the holes at the top and then swinging the cover down until it clicks into place.

### CLEANING THE TURBO BRUSH

- 1 Slide the locking latch (a) forward and gently tilt brush housing upward to open. (Fig. 23)  
**IMPORTANT:** DO NOT force; it will not open all the way.
- 2 Carefully remove any blockage or debris.
- 3 Turn the turbo brush over to inspect the rotating brush and cut away any build-up of hair or string wrapped around the rotating bristle brush with scissors. (Fig. 24)
- 4 Push the housing back down and slide the locking latch backward to lock.



Make sure you are working in a well lit area and use a flashlight to help search for blockages.

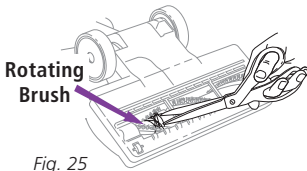

Fig. 25

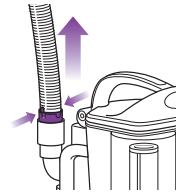

Fig. 26

## CLEANING THE MOTORIZED FLOOR BRUSH

When your motorized floor brush needs cleaning or locks onto an object, it automatically shuts down to prevent damage to your lifetime belt. The indicator light will illuminate red warning you to turn off the vacuum and clear blockage immediately. The light will reset itself once blockage has been cleared and power has been cycled on/off or vacuum has been locked in the upright position.

- 1 Detach the motorized floor brush from the detachable canister.
- 2 Inspect the opening underneath and the rotating brush. If a build-up of debris is present, remove it. Carefully cut anything wound around the rotating brush with scissors. Avoid damaging or cutting the bristles. (Fig. 25)

## CHECKING FOR BLOCKAGES

Blockages may cause your vacuum to overheat and shut down. To prevent this from happening, check potential blockage areas after heavy use or if you detect a loss of suction or poor cleaning performance.

### 1 Dust Cup

Dust cup may be full. Empty dust cup.

### 2 Pre-Motor & Post-Motor Filters

Pre-motor filters require washing every 3 months for optimum performance. The post-motor HEPA filter needs to be washed every 2 years.

Ensure that all the filters are clean.

### 3 Accessories

- Check intake openings:
  - Extension Wand
  - Dusting Brush
  - Crevice Tool
  - Turbo Brush

### 4 Hose and Connections to Vacuum

- Detach the stretch hose from the back of the detachable canister by squeezing the tabs together and pulling up. (Fig. 26) Straighten out the hose and look inside for blockages.

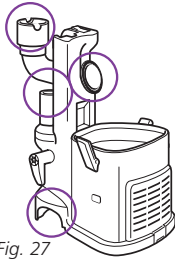

Fig. 27

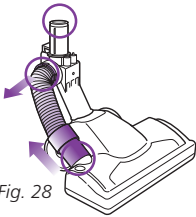
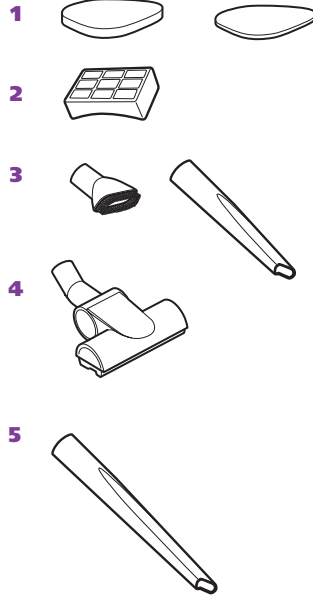

Fig. 28

- Remove the dust cup and extension wand and separate the detachable canister from the motorized floor brush. Look in all 4 openings for any blockages. (Fig. 27)

## 5 Motorized Floor Brush

- Detach the hose on the motorized floor brush at the top by squeezing the tabs together and pulling out, and at the bottom by pulling out the connector. Inspect inside the 3 holes. (Fig. 28)



PART	PART NO.
1 Pre-Motor Filter Set	XFF350
2 HEPA Filter	XHF350
3 Dusting Brush & Crevice Tool	112FFJ
4 Turbo Brush	1117FC
5 24" Crevice Tool	1124-FC

To order additional parts or accessories go to [www.sharkclean.com](http://www.sharkclean.com) or call 1-800-798-7398.



# Troubleshooting Guide

PROBLEM	POSSIBLE REASONS & SOLUTIONS
<b>Vacuum is not picking up dirt.</b>	<p>Check filters to see if they need cleaning. Follow instructions for rinsing and drying the filters before re-inserting back into the vacuum. (See "Maintenance" sections for instructions.)</p> <p>Dust cup may be full; empty dust cup.</p> <p>Check hose and hose connections for blockages; clear blockages if required. If dust cup is empty, and attachment inlets are clear, check for other blockages. (See "Checking for Blockages" for instructions.)</p>
<b>Vacuum lifts scatter rugs (lightweight, movable rugs).</b>	<p>Suction is powerful. Take care when vacuuming scatter-type rugs or rugs with delicately sewn edges. Open the suction release on the handle to decrease suction power.</p> <p>Move the On/Off switch to "I - Suction Only" position to disengage the brush roll</p>
<b>Airflow is restricted. No suction or light suction.</b>	<p>Check filters to see if they need cleaning. Follow instructions for rinsing and drying the filters before re-inserting back into the vacuum.</p> <p>Dust cup may be full; empty dust cup.</p> <p>Check hose, hose connections, nozzles and accessories for blockages; clear blockages if required.</p> <p>Close the suction release on the handle to increase suction power.</p> <p>If dust cup is empty, and attachment inlets are clear, check for other blockages.</p>
<b>Brush roll does not spin</b>	<p>Immediately turn off and unplug vacuum, disconnect the nozzle and remove blockage before reconnecting and turning vacuum back on.</p> <p>Pull the handle toward you and release the floor nozzle to disengage the auto-off feature.</p> <p>Move the On/Off switch to the "II - Brush Roll On" position.</p>
<b>Vacuum turns off on its own.</b>	<p>This vacuum cleaner is equipped with a motor protective thermostat. If for some reason your vacuum overheats, the thermostat will automatically turn the unit off. Should this occur, perform the following steps to restart the motor thermostat:</p> <ol style="list-style-type: none"><li>1. Move the On/Off switch to the "O" (Off) position.</li><li>2. Unplug the vacuum.</li><li>3. Empty the dust cup and clean filters.</li><li>4. Check for blockages in hose, accessories and inlet openings.</li><li>5. Allow the unit to cool for a minimum of 45 minutes.</li><li>6. Plug in the vacuum.</li><li>7. Turn the On/Off switch to the "I" (On) position to restart the vacuum.</li></ol>

## **EURO-PRO FIVE-YEAR (5) LIMITED WARRANTY**

**EURO-PRO Operating LLC** warrants this product to be free from material defects and workmanship for a period of five (5) years from the date of purchase when utilized for normal household use, subject to the following conditions, exclusions and exceptions.

The liability of **EURO-PRO Operating LLC** is limited solely to the cost of the repair or replacement of the unit at our option. This Limited Warranty does not cover normal wear of parts and does not apply to any unit that has been tampered with or used for commercial purposes. This Limited Warranty does not cover damage caused by misuse, abuse, negligent handling or damage due to faulty packaging or mishandling in transit. This Limited Warranty does not cover damage or defects caused by or resulting from damages from shipping or repairs, service or alteration to the product or any of its parts, which have been performed by a repair person not authorized by **EURO-PRO Operating LLC**.

If your appliance fails to operate properly while in use under normal household conditions within the warranty period, you may return the complete appliance and accessories with proof of purchase and date, freight prepaid. For customer service support, call 1-800-798-7398 or visit our website at [www.sharkclean.com](http://www.sharkclean.com).

If the appliance is found by **EURO-PRO Operating LLC** to be defective, in **EURO-PRO Operating LLC's** sole discretion, we will repair or replace it free of charge. Proof of purchase date and a check made payable to **EURO-PRO Operating LLC** in the amount of \$19.95 to cover the cost of return shipping and handling must be included.\*

Non-durable parts including, without limitation, filters, brushes and electrical parts which normally require replacement are specifically excluded from warranty.

This Limited Warranty is extended to the original purchaser of the unit and excludes all other legal, implied and/or conventional warranties. The responsibility of **EURO-PRO Operating LLC** if any, is limited to the specific obligations expressly assumed by it under the terms of this Limited Warranty. **In no event is EURO-PRO Operating LLC** liable for incidental or consequential damages to anyone of any nature whatsoever. Some states do not permit the exclusion or limitation of incidental or consequential damages, so the above may not apply to you.

This Limited Warranty gives you specific legal rights, and you may also have other rights which vary from state to state or province to province.

**\*IMPORTANT: Carefully pack item to avoid damage in shipping. Be sure to include proof of purchase date and to attach a tag to item before packing including your name, complete address and phone number with a note giving purchase information, model number and what you believe is the problem with the item. We recommend you insure the package (as damage in shipping is not covered by your warranty). Mark the outside of your package "ATTENTION CUSTOMER SERVICE". We are constantly striving to improve our products, therefore the specifications contained herein are subject to change without notice.**



Copyright © Euro-Pro Operating LLC 2014

Printed in China

Illustrations may differ from actual product.

NV352Q.140213.1