



Earn BISSELL Rewards!

Register your product today!

See details on back page

LIFT-Off[®] DEEP CLEANER

USER'S GUIDE

24A4, 30K7, 66E1, 80X9 SERIES

- 2 Thank You
- 3 Safety Instructions
- 4-5 Product View
- 6 Assembly
- 7-12 Operations
- 13-15 Maintenance and Care
- 16 Troubleshooting
- 17 Accessories
- 18 Replacement Parts
- 19 Warranty
- 20 Product Registration
- 20 Consumer Care



Thanks for buying a BISSELL Deep Cleaner

We're glad you purchased a BISSELL deep cleaner. Everything we know about floor care went into the innovative design and construction of this complete, high-tech home cleaning system.

Your BISSELL deep cleaner is well made, and we back it with a limited two year warranty. We also stand behind it with a knowledgeable, dedicated Consumer Care department, so, should you ever have a problem, you'll receive fast, considerate assistance.

My great-grandfather invented the floor sweeper in 1876. Today, BISSELL is a global leader in the design, manufacture, and service of high quality homecare products like your BISSELL deep cleaner.

Thanks again, from all of us at BISSELL.

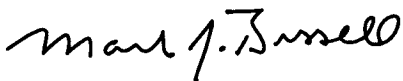

Mark J. Bissell
Chairman & CEO

DETACHABLE INNOVATION

Complete Line of BISSELL Lift-Off® Products



Lift-Off®
Steam Mop



Lift-Off®
Deep Cleaner



Lift-Off®
Multi Cyclonic
Vacuum



Lift-Off®
Floors & More
Cordless Stick Vacuum

For more information visit www.bissell.com

IMPORTANT SAFETY INSTRUCTIONS

When using an electrical appliance, basic precautions should be observed, including the following:

READ ALL INSTRUCTIONS BEFORE USING YOUR DEEP CLEANER.

⚠ WARNING: To reduce the risk of fire, electric shock, or injury:

- Do not immerse.
- Use only on surfaces moistened by the cleaning process.
- Always connect to a properly grounded outlet.
- See Grounding Instructions.
- Unplug from outlet when not in use and before conducting maintenance or troubleshooting.
- Do not leave machine when it is plugged in.
- Do not service machine when it is plugged in.
- Do not use with damaged cord or plug.
- If appliance is not working as it should, has been dropped, damaged, left outdoors, or dropped into water, have it repaired at an authorized Service Center.
- Do not expose to rain, store indoors.
- Do not pull or carry by cord, use cord as a handle, close door on cord, pull cord around sharp corners or edges, run appliance over cord, or expose cord to heated surfaces.
- Unplug by grasping the plug, not the cord.
- Do not handle plug or appliance with wet hands.
- Do not put any object into appliance openings, use with blocked opening, or restrict air flow.
- Do not expose hair, loose clothing, fingers or body parts to openings or moving parts.
- Do not pick up hot or burning objects.
- Do not pick up flammable or combustible materials (lighter fluid, gasoline, kerosene, etc.) or use in the presence of explosive liquids or vapor.
- Do not use appliance in an enclosed space filled with vapors given off by oil base paint, paint thinner, some moth proofing substances, flammable dust, or other explosive or toxic vapors.
- Do not pick up toxic material (chlorine bleach, ammonia, drain cleaner, gasoline, etc.).
- Do not modify the 3-prong grounded plug.
- Do not allow to be used as a toy.
- Do not use for any purpose other than described in this User's Guide.
- Do not unplug by pulling on the cord.
- Use only manufacturer's recommended attachments.
- Use only cleaning products formulated by BISSELL for use in this appliance to prevent internal component damage. See the cleaning fluid section of this guide.
- Keep openings free of dust, lint, hair, etc.
- Do not point attachment nozzle at people or animals
- Keep appliance on a level surface.
- Turn off all controls before unplugging.
- Unplug before attaching the TurboBrush® Tool.

- Be extra careful when cleaning stairs.
- Close attention is necessary when used by or near children.

SAVE THESE INSTRUCTIONS.

THIS MODEL IS FOR HOUSEHOLD USE ONLY.

GROUNDING INSTRUCTIONS

This appliance must be connected to a grounded wiring system. If it should malfunction or break down, grounding provides a safe path of least resistance for electrical current, reducing the risk of electrical shock. The cord for this appliance has an equipment-grounding conductor and a grounding plug. It must only be plugged into an outlet that is properly installed and grounded in accordance with all local codes and ordinances.

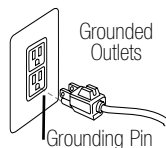

⚠ WARNING:

Improper connection of the equipment-grounding conductor can result in a risk of electrical shock. Check with a qualified electrician or service person if you aren't sure if the outlet is properly grounded. **DO NOT MODIFY THE PLUG.** If it will not fit the outlet, have a proper outlet installed by a qualified electrician. This appliance is designed for use on a nominal 120-volt circuit, and has a grounding attachment plug that looks like the plug in the drawing above. Make certain that the appliance is connected to an outlet having the same configuration as the plug. No plug adapter should be used with this appliance.

Product view

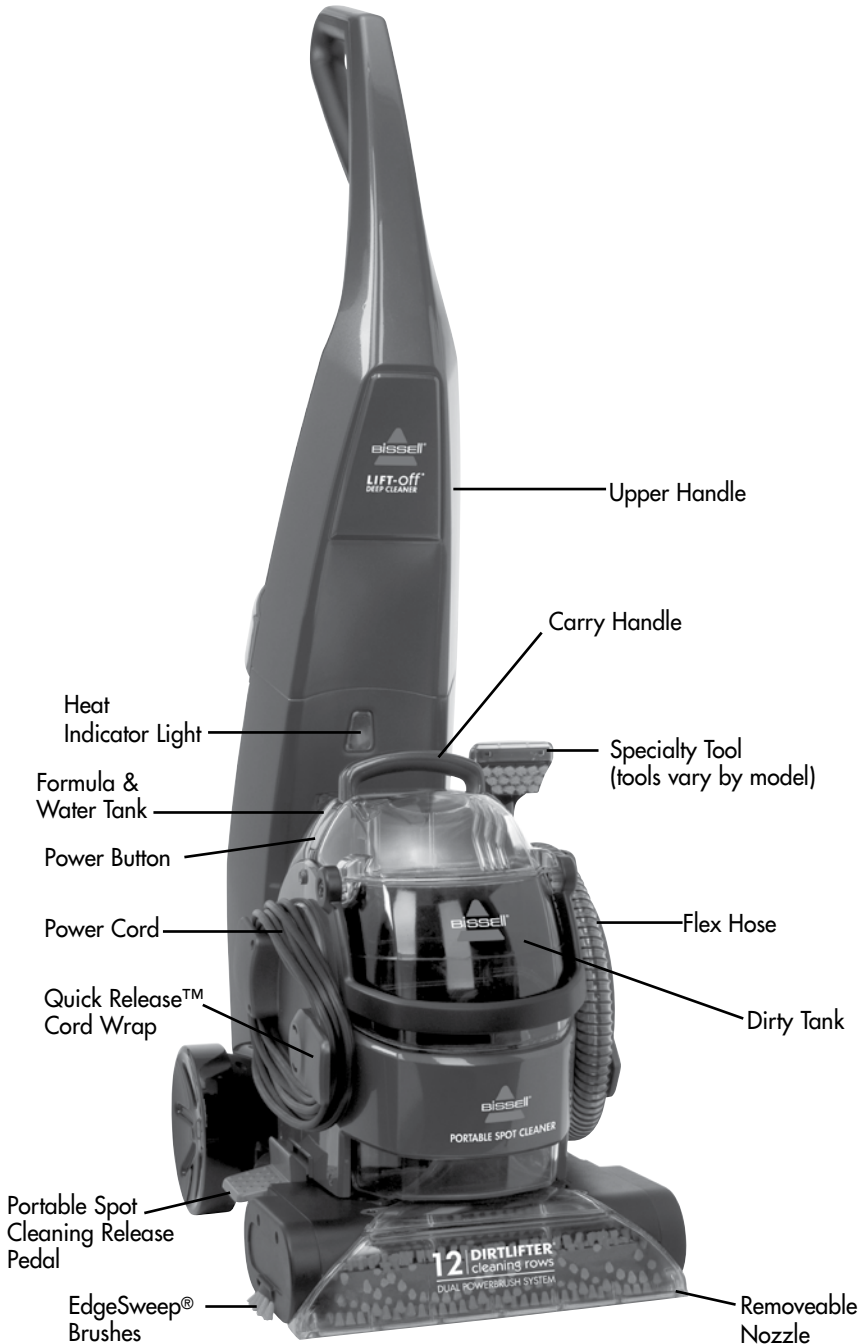

Product view

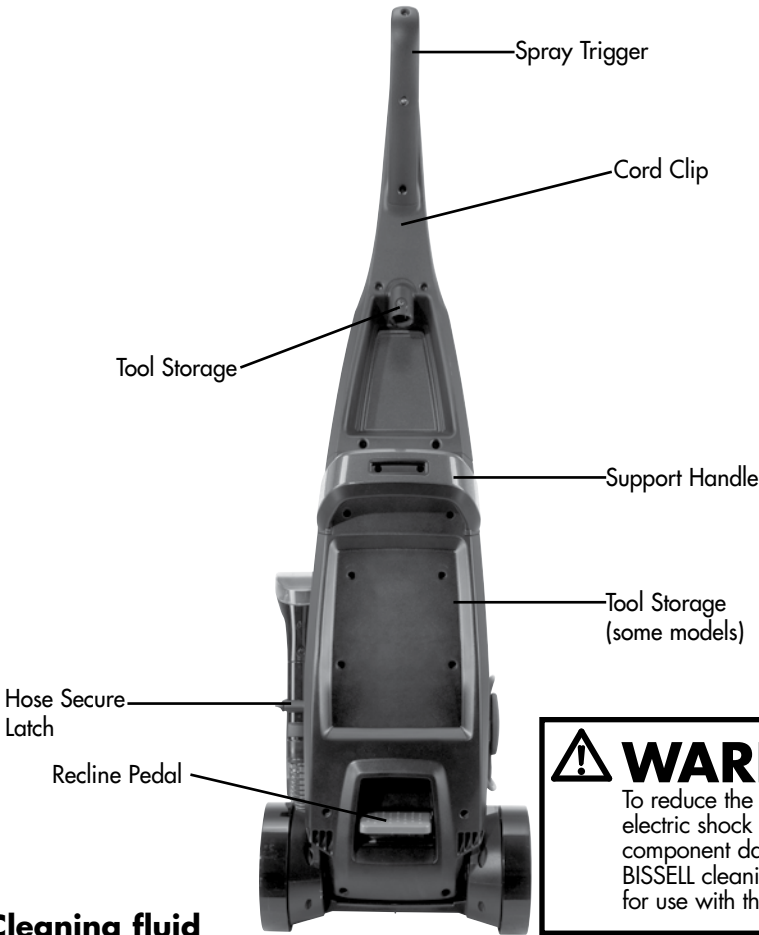

⚠ WARNING:

To reduce the risk of fire and electric shock due to internal component damage, use only BISSELL cleaning fluids intended for use with the deep cleaner.

Cleaning fluid

Keep plenty of genuine BISSELL 2X formula on hand so you can clean and protect whenever it fits your schedule. Always use genuine BISSELL deep cleaning formulas. Non-BISSELL cleaning solutions may harm the machine and will void the warranty.

	Professional Deep Cleaning	Pet Stain & Odor	Deep Clean & Protect	Allergen Cleansing	Spring Breeze	Crystal Springs	Pet Stain & Odor Pretreat	Tough Stain Pretreat
Best for	Out Cleans all other formulas	Removes tough pet stains and contains patented odor removal technology	Deep cleans carpets and protects from future stains with Scotchgard™ Protector	Helps remove pet & pollen allergens	Powerful cleaning with a refreshing scent	Powerful cleaning with a refreshing scent	Pretreat to help remove tough pet stains and odors	Pretreat to penetrate and loosen tough stains
2X Concentrated	X	X	X	X	X	X		
Scotchgard™ Protection	X	X	X					

Assembly

Your deep cleaner comes in two easy to assemble components:

1. Upper handle
2. Portable spot cleaner/Base

The only tool you will need to assemble your cleaner is a Phillips screwdriver.

1. Slide the upper handle onto the body of the machine by guiding the 2 posts on the body into the opening on the upper handle.
2. Firmly holding the upper handle in place, screw 2 screws into the marked holes at an upward angle above the support handle.
3. At an upward angle, screw the remaining 2 screws into the marked outermost holes under the support handle.
4. Wrap power cord around Quick Release Cord Wrap.
5. Wrap flex hose around the hose wrap and secure with hose secure latch.
6. Align the product as image 4 shows and firmly push down the portable spot cleaner until it is secured on both sides.

To further check if the portable spot cleaner is secure, plug in and turn on to verify that the heat indicator light is illuminated. If the heat indicator light does not illuminate, release the pod and re-secure by pushing firmly until both sides snap into place.

7. Check latches on both sides to confirm it is secured (5).
8. Snap attachment(s) into the back of unit.
NOTE: Portable spot cleaner must be fully secure to operate in the upright mode.

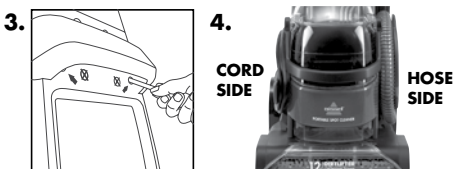
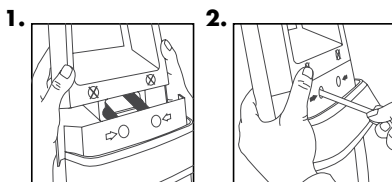
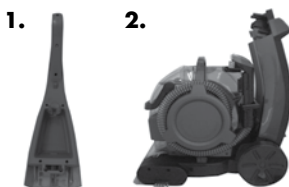

WARNING:

Do not plug in your cleaner until you have completely assembled it per the above instructions and are familiar with all instructions and operating procedures.

Operations

Special features

Innovative cleaning technology

This innovative deep cleaner offers two machines in one. The upright deep cleaner uses the power of heat, brushes and cleaning formula to get deep down dirt for a maximum clean. The portable spot cleaner detaches to clean tough spots and stains and hard to reach areas.

Heatwave Technology™

This deep cleaner features Heatwave Technology to maintain the temperature of the hot tap water you put in to safely optimize cleaning effectiveness. Water in the clean tank is heated by heat from the vacuum motor. The Heatwave Technology automatically turns on when you turn the machine on. Heatwave Technology operates in both upright and portable cleaning modes.

Scotchgard™ Protector

Carpet protection applied at the mill typically wears down over time from heavy foot traffic and everyday cleaning, including deep cleaning. To help restore this important protection, only BISSELL offers deep cleaning formulas with Scotchgard protector. This offers extra protection against dirt and tough stains to keep your carpets looking good longer.

To maintain your carpet's Scotchgard 5-year limited stain warranty, you do not need to hire a professional. By using your BISSELL deep cleaner with BISSELL 2X formulas containing Scotchgard protector every 12 months, your carpet warranty from 3M remains in effect. No other home deep cleaning system can do this for you. Refer to the Scotchgard Protector warranty for details.



Pedal Graphic

Tip:

For easy carrying, grab the carry handle portable spot cleaner and balance with the handle on the back of the machine.



Operations

Before you clean

1. Move furniture to another area if cleaning an entire room (optional).
2. For best results, vacuum area with a dry vacuum cleaner thoroughly before deep cleaning.
3. Pretreating (optional):
 - 3a. Pretreating is recommended to improve cleaning effectiveness for heavily soiled carpet in high traffic areas such as entryway and hallways.

3b. BISSELL Tough Stain precleaner

Spray the BISSELL Tough Stain precleaner formula onto heavy traffic areas, soiled areas or stains.

Allow to penetrate for at least 3 minutes.

Clean as normal, using the deep cleaner in upright mode, following the instructions below.

ATTENTION:

Some Berber carpets have a tendency to fuzz with wear. Repeated strokes in the same area with an ordinary vacuum or deep cleaner may aggravate this condition.



Upright cleaning mode

Filling formula & water tank

1. Remove tank from the base of the machine by lifting up tank carry handle.

NOTE: This tank was designed with a flat bottom so it can be easily filled.

2. Unscrew the black cap and remove bottle insert.
3. Fill tank with hot tap water to the water fill line. Add two ounces of BISSELL 2X formula to the tank.
4. Replace the bottle insert in the tank and tighten the black cap. Replace the tank on the deep cleaner.

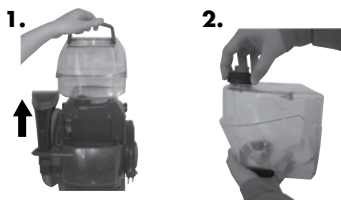

Cleaning

1. Plug into a proper outlet and press the power button.
2. While pressing the trigger, make one slow forward wet pass and another one back.

Operations

Upright cleaning mode continued

Cleaning continued

3. Release the trigger and make one slow forward and backward pass over the same area. Repeated passes will help aid in dry time.
4. Continue passes until cleaning area is complete.

Note: Your machine may be equipped with a circuit breaker that will automatically shut off the brush if a large or loose object is caught in the brush roll. If that happens, be sure to unplug your machine, remove the foreign object, and then plug the machine back in to reset the circuit breaker.

Empty dirty tank

1. When the dirty tank reaches the "FULL" line on the tank it is time to empty.
2. Remove dirty tank and carry to a utility sink, toilet or outside (where you will dispose of the dirty water).
3. To unlock the dirty tank lid, rotate handle over the back of the tank. Remove lid and pour out dirty water. Rinse out dirty tank to remove any debris.
4. Replace top of tank, and rotate the handle forward to lock in place on front of tank.
5. Before replacing tank on machine, wipe debris from red filter

Cleaning your machine

1. Flush out machine of any remaining residual solution.

Fill the formula & water tank with hot tap water and turn on your machine.

Recline handle and press the spray trigger for about 15 seconds while making forward and backward passes on carpet. Continue without pressing the trigger until there is no more water being suctioned up.

Turn off the machine and wrap the powercord. Make sure the dirty tank and the formula & water tank are emptied, rinsed, and dried before the next use.

Before you replace tank, clean all debris from red filter screen.

CAUTION:

Do not overwet. Take care not to run over loose objects or edges of area rugs. Stalling brush may result in premature belt failure.

Tip:

Make only one trip to the sink by removing the entire portable cleaner. Fill and empty in the same trip.



WARNING:

To reduce the risk of fire, electric shock, or injury, turn power OFF and disconnect plug from electrical outlet before performing maintenance or troubleshooting.

Tip:

For best results empty, rinse and dry both tanks before storing.

Operations

Upright cleaning mode continued

Cleaning your machine continued

2. Rinse front nozzle of any dirt and debris.

Remove portable spot cleaner from the base of the machine.

Unscrew three screws with Phillips screw driver and remove nozzle.

Rinse nozzle out at the faucet.

Place back onto the machine by hooking the tabs into the holes on the bottom sides of the machine. Secure with screws.

3. The inside of the end caps can be wiped out with a clean paper towel, or for a more thorough clean, the end caps can be taken off and rinsed clean.

4. Any loose hair or debris can be pulled from the brush rolls and thrown away. For a more thorough clean, follow directions on page 15 for removal of brush rolls. Your machine is now ready to be stored.

NOTE: Store cleaner in a protected, dry area. Since this product uses water, it must not be stored where there is a danger of freezing. Freezing will damage internal components and void the warranty.



WARNING:

To reduce the risk of fire, electric shock or injury unplug from outlet before servicing.

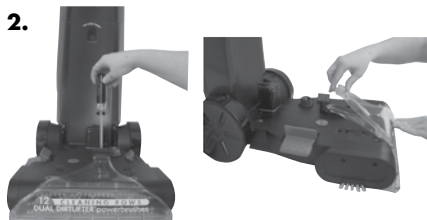

Tip:

Let all parts dry completely and replace onto machine.

Operations

Portable spot cleaning mode

Preparing the machine

1. Step on the portable spot cleaning pedal to release the portable spot cleaner.
2. Release flex hose by twisting the hose secure latch clockwise. Unwrap flex hose completely.
3. Attach the desired tool to the hose grip until it snaps together. Make certain the tool is securely attached.
4. Twist the Quick Release cord wrap clockwise to unwrap the power cord completely and plug into grounded outlet.

Filling tank

1. Follow the instructions for filling the tank in the upright cleaning mode section on page 8.

Cleaning with Tools:

IMPORTANT! If using to clean upholstery, check upholstery tags. Check manufacturer's tag before cleaning. "W" or "WS" on the tag means you can use your Lift off Deep Cleaner if the tag is coded with an "X" or an "S"(with a diagonal stripe through it), or says "Dry Clean Only", do not proceed with any deep cleaning machine. Do not use on velvet or silk. If manufacturer's tag is missing or not coded, check with your furniture dealer."

1. Hold the tool approximately 1" above the soiled surface. Press the spray trigger to apply the cleaning solution to the soiled area.

NOTE: Hold end of hose below the tank water level to help prime the portable spot cleaner.

2. Using the brush on the tool, gently scrub the area to be cleaned.
3. Apply downward pressure on the tool and pull it toward you. The suction will remove the dirt and cleaning solution. Continue until no more dirt can be removed.

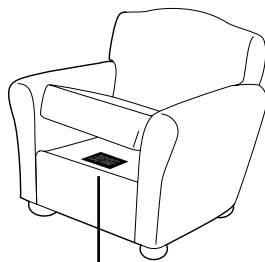

Manufacturer's tag

Check for colorfastness in an inconspicuous place. If possible, check upholstery stuffing. Colored stuffing may bleed through fabric.

Operations

Portable spot cleaning mode continued

Cleaning with Deep Reach™ Tool

1. Set tool on soiled surfaces and press the trigger to spray solution onto the soiled area to be cleaned.
2. Slowly move the tool back and forth over the soiled surface, keeping the tool in contact with the carpet.
3. Release trigger and move tool slowly over the soiled area to suction up water and dirt.
4. Continue to clean the area, working in small sections, until no more dirt can be removed.

1.

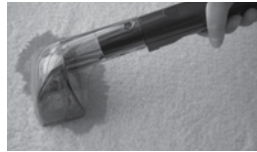

3.

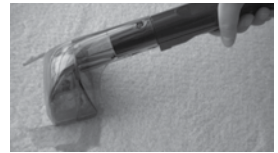

Empty dirty tank

Follow the instructions under Empty dirty tank section on page 9 of the Upright cleaning mode section.

Replacing portable machine on base

1. Align the product with the cord side on the left and hose side on the right.
2. Push down the portable spot cleaner until both sides click securely into place. Test the fit by pulling up on the carry handle to make sure it is secure.

1.

**CORD
SIDE**



**HOSE
SIDE**

Cleaning portable machine

1. Remove and rinse the tools in clean, running water. Dry and replace in the tool storage provided.
2. It is recommended that you suction clean water from a bowl to rinse out the hose. Then lift end of hose and stretch out to ensure all water is cleared from hose.
3. Coil flex hose around the hose wrap and secure with latch.
4. Check suction gate and if it appears dirty, follow steps 1-4 under Cleaning Suction Gate on page 13.

Maintenance and care

Machine care (check regularly)

Cleaning suction gate

The suction gate automatically diverts air when the portable deep cleaner is detached. This should be checked and cleaned regularly for any dirt and debris.

1. Step on the pedal and remove the portable spot cleaner. Remove dirty tank.
2. Remove two screws and pull off suction gate door.
3. Wipe suction gate clean and rinse suction gate door.
4. Replace suction gate door and two screws.

Cleaning spray tips

1. Step on the pedal and remove the portable spot cleaner. To remove each spray tip, push tab in and pull it out.
2. Clean by rinsing under hot water.
3. Replace by snapping back in.



WARNING:

To reduce the risk of fire, electric shock, or injury, turn power OFF and disconnect plug from electrical outlet before performing maintenance or troubleshooting.

2.



1.



Maintenance and care

Small belt removal and replacement (as needed)

Occasional replacement of one or both belts may become necessary. If that is needed, please follow the instructions below.

1. Turn off the machine, and unplug it from the outlet. Remove portable spot cleaner.
2. Remove the nozzle by unscrewing three screws on the nozzle cover.
3. Turn the machine on its side.
IMPORTANT: with portable spot cleaning pedal facing down.
4. Remove end cap by unscrewing the 3 screws. Take care not to drop the screws into the unit.
5. Remove 1 silver screw from the pivot arm.
6. Remove pivot arm by gently lifting up.
7. Remove small brush belt.
8. Replace small brush belt, and reverse steps above.
9. Manually rotate brushes by hand to make sure they move freely. May notice a slight resistance from the motor.

WARNING:

To reduce the risk of fire, electric shock or injury, unplug from the outlet before servicing.

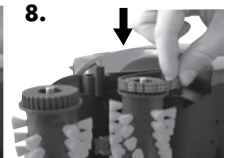
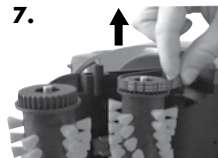

Maintenance and care

Brush removal and large belt replacement (as needed)

Brushes can be removed for cleaning or replacement as needed.

1. Follow small belt removal Instructions on page 14 items 1-7.
2. Remove brush rolls by pulling them off of the metal rods. **Be careful not to lose the small washer at each end of the brush rolls.**
3. Re-attach the large belt to the grooves on the end of the new brush rolls. If the belt is damaged, replace with a new belt.
4. Place cleaned or new brush rolls back onto the rods. Make sure one washer is on each end of the rollers prior to sliding onto the rod. Be sure the brush is seated completely on the rod.
5. Replace small belt over grooves in back roller and metal cog.
6. Replace pivot arm and secure with silver screw.
7. Re-attach end cap by tightening with the (3) black screws.
8. Return front nozzle to front of unit, by latching from underneath and then securing with 3 screws.
9. Follow step number 8 & 9 on page 14. If you have any questions or are having trouble installing or replacing your belt(s) or brushes, please call **BISSELL Consumer Care.**

WARNING:

To reduce the risk of fire, electric shock or injury, unplug from the outlet before servicing.

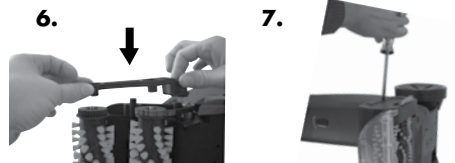
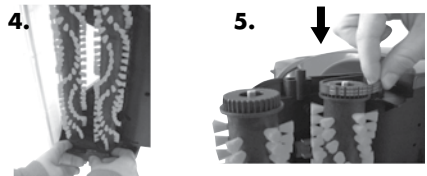
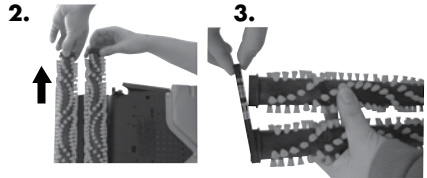

Troubleshooting

Heater indicator light does not illuminate

Possible causes

1. The power is not turned ON
2. The portable spot cleaner is not attached completely

Reduced Spray or No Spray

Possible causes

1. Formula & water tank may be empty
2. Formula & water tank may not be seated completely
3. Pump may have lost prime in portable spot cleaning mode
4. The portable spot cleaner is not attached completely

DirtLifter® PowerBrush does not turn

Possible causes

1. The portable spot cleaner is not attached completely
2. The unit is in the upright position
3. Circuit breaker on machine (if equipped) may have tripped
4. The belt is off or broken

Loss of suction power

Possible causes

1. Tanks may not be seated properly
2. Nozzles may not be assembled properly
3. The portable spot cleaner is not attached completely
4. Dirty tank has picked up maximum amount of dirty water and has reached full line
5. Formula & water tank is empty
6. Suction Gate is open.

Other maintenance or service not included in the manual should be performed by an authorized service representative.

Thank you for selecting a BISSELL product.

Please do not return this product to the store.

For any questions or concerns, BISSELL is happy to be of service. Contact us directly at 1-800-237-7691.

WARNING:

To reduce the risk of fire, electric shock or injury, unplug from the outlet before servicing.

Remedies

1. The power must be ON to activate the heater indicator light
2. Make sure the portable spot cleaner is attached
Push down firmly to check (see pages 6 or 12 for detailed instructions)

Remedies

1. Refill tank
2. Turn power OFF. Remove and reset tank
3. Hold end of hose below water level in tank to prime
4. Push down firmly to check connection

Remedies

1. Make sure the portable spot cleaner is attached.
Push down firmly to check (see pages 6 or 12 for detailed instructions)
2. Brushes only rotate when unit is reclined using the recline pedal
3. Turn the machine OFF and unplug from outlet. Check to see if foreign object is caught in brush roll. Remove object. Plug machine in to reset circuit breaker
4. Turn power OFF and unplug unit from outlet. Follow instructions on pages 14 and 15

Remedies

1. Pick up both tanks and reseal them so they fit snugly on the unit
2. Unplug the unit. Check to make sure the "lip" of the nozzle cover is securely hooked into the groove on the top of nozzle (see page 10)
3. Make sure the portable spot cleaner is attached.
Push down firmly to check (see pages 6 or 12 for detailed instructions)
4. Empty dirty tank
5. Check fluid levels in formula & water tank
6. Check to make sure the suction gate is closed. Follow "Cleaning Suction Gate" instructions on page 13.

Accessories - BISSELL deep cleaner

These items are available for purchase as accessories for your BISSELL deep cleaner: To purchase call 1-800-237-7691 or visit www.bissell.com.

Item	Part No.	Part Name
1	203-6651	3" Tough Stain Tool
2	203-6652	Powered TurboBrush® Hand Tool
3	203-6653	4" Upholstery Tool
4	203-6654	6" Stair Tool
5	203-7885	Spraying Crevice Tool
6	203-7412	Deep Reach Pet Tool
7	62E5-2	2X Deep Clean & Protect Formula with Scotchgard™ Protection 60 oz.
8	99K5-2	2X Pet Stain and Odor Formula with Scotchgard™ Protection 60 oz.
9	89Q5-2	2X Allergen Cleansing Formula 60 oz.
10	7919-3	2X Crystal Springs Formula 60 oz.
11	78H6-3	2X Professional Deep Cleaning Formula with Scotchgard™ Protection 48 oz.
12	26V2-A	2X Spring Breeze Formula 60oz.
13	0790	Pet Stain and Odor Remover™ 22 oz.
14	4001	Tough Stain PreCleaner 22 oz.
15	210-3040	Mesh Bag

*Not all parts are included with every model.



Replacement parts – BISSELL deep cleaner

Below please find a list of common replacement parts. While not all of these parts may have come with your specific machine, all are available to you for purchase, if desired.

Item	Part No.	Part Name
1	203-7893	Formula & Water Tank Assembly (includes cap and insert)
2	203-6675	Cap and Insert for Formula & Water Tank
3	203-7894	Collection Tank Bottom
4	203-7904	Cord Wrap
5	203-7896	End Caps with Edge Brushes (2 pack, includes screws)
6	203-7897	Spray Tips Assembly (includes two spray tips)
7	203-7906	Nozzle Cover Top w/Gasket
8	203-7907	Nozzle Cover Lower and Front w/Gasket
9	203-6686	Brush Single Pack (includes 1 brush roll, and 1 axle)
10	203-6688	Small Brush Belt
11	203-6804	Large Brush Belt
12	203-6689	Hose Secure Latch
13	203-7918	Dirty Tank Gasket Assembly (include both gaskets)
14	203-7917	Diverter Cover Assembly (includes cover and screws)

*Not all parts are included with every model.

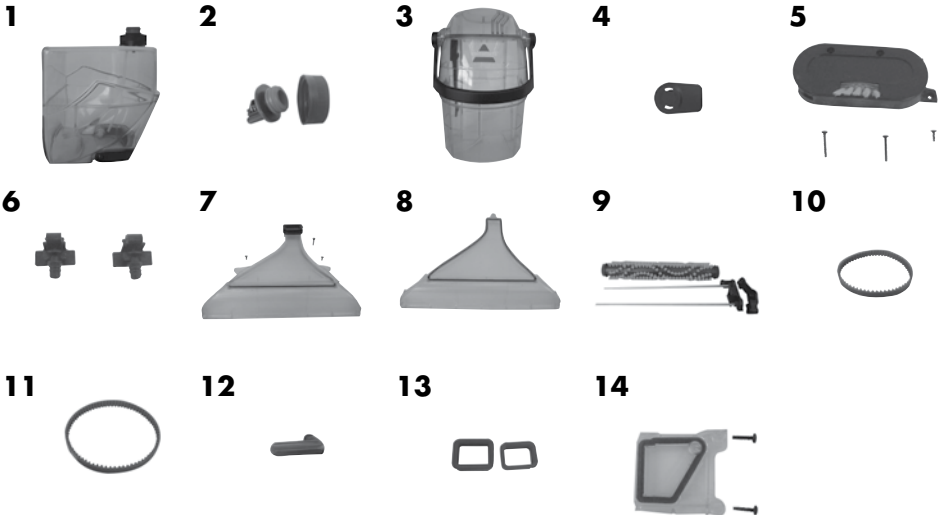

Warranty – BISSELL Deep Cleaner

This warranty gives you specific legal rights, and you may also have other rights which may vary from state to state. If you need additional instruction regarding this warranty or have questions regarding what it may cover, please contact BISSELL Consumer Care by E-mail, telephone, or regular mail as described below.

Limited Two Year Warranty

Subject to the *EXCEPTIONS AND EXCLUSIONS identified below, upon receipt of the product BISSELL will repair or replace (with new or remanufactured components or products), at BISSELL's option, free of charge from the date of purchase by the original purchaser, for two year any defective or malfunctioning part.

See information below on "If your BISSELL product should require service".

This warranty applies to product used for personal, and not commercial or rental service. This warranty does not apply to fans or routine maintenance components such as filters, belts, or brushes. Damage or malfunction caused by negligence, abuse, neglect, unauthorized repair, or any other use not in accordance with the user's guide is not covered.

If your BISSELL product should require service:

Contact BISSELL Consumer Care to locate a BISSELL Authorized Service Center in your area.

If you need information about repairs or replacement parts, or if you have questions about your warranty, contact BISSELL Consumer Care.

Website or E-mail:

www.bissell.com

Or Call:

BISSELL Consumer Care

1-800-237-7691

Monday – Friday 8 am - 10 pm ET

Saturday 9 am - 8 pm ET

Sunday 10am - 7pm ET

Or Write:

BISSELL Homecare, Inc.

PO Box 3606

Grand Rapids, MI 49501

ATTN: Consumer Care

BISSELL IS NOT LIABLE FOR INCIDENTAL OR CONSEQUENTIAL DAMAGES OF ANY NATURE ASSOCIATED WITH THE USE OF THIS PRODUCT. BISSELL'S LIABILITY WILL NOT EXCEED THE PURCHASE PRICE OF THE PRODUCT.

Some states do not allow the exclusion or limitation of incidental or consequential damages, so the above limitation or exclusion may not apply to you.

*EXCEPTIONS AND EXCLUSIONS FROM THE TERMS OF THE LIMITED WARRANTY

THIS WARRANTY IS EXCLUSIVE AND IN LIEU OF ANY OTHER WARRANTIES EITHER ORAL OR WRITTEN. ANY IMPLIED WARRANTIES WHICH MAY ARISE BY OPERATION OF LAW, INCLUDING THE IMPLIED WARRANTIES OF MERCHANTABILITY AND FITNESS FOR A PARTICULAR PURPOSE, ARE LIMITED TO THE TWO YEAR DURATION FROM THE DATE OF PURCHASE AS DESCRIBED ABOVE.

Some states do not allow limitations on how long an implied warranty last so the above limitation may not apply to you.



Don't forget to register your product!

Registering is quick, easy and offers you benefits over the lifetime of your product. You'll receive:

BISSELL Rewards Points

Automatically earn points for discounts and free shipping on future purchases.

Faster Service

Supplying your information now saves you time should you need to contact us with questions regarding your product.

Product Support Reminders and Alerts

We'll contact you with any important product maintenance reminders and alerts.

Special Promotions

Optional: Register your email to receive notice of offers, contests, cleaning tips and more!

Visit www.bissell.com/registration now!



BISSELL Consumer Care

For information about repairs or replacement parts, or questions about your warranty, call:

BISSELL Consumer Care
1-800-237-7691

Monday – Friday 8 am - 10 pm ET

Saturday 9 am - 8 pm ET

Sunday 10 am - 7 pm ET

Or write:

BISSELL Homecare, Inc.

PO Box 3606

Grand Rapids MI 49501

ATTN: Consumer Care

Or visit the BISSELL website - **www.bissell.com**

When contacting BISSELL, have model number of cleaner available.

Please record your Model Number: _____

Please record your Purchase Date: _____

NOTE: Please keep your original sales receipt. It provides proof of purchase date in the event of a warranty claim. See Warranty on page 19 for details.



©2013 BISSELL Homecare, Inc.
Grand Rapids, Michigan
All rights reserved. Printed in China
Part Number 160-0928
Rev 01/13
Visit our website at:
www.bissell.com
Scotchgard is a trademark of 3M

