



9ft Solar Olefin Double Top Market Umbrella

Assembly and User Manual

ITEM: #UMB-015364
UMB-015371
UMB-015340
UMB-015357
M45904



The schematics in this manual are for assembly and operation illustration only. They may differ from the umbrella's actual appearance.



www.atleisure.com
ATLANTA, GEORGIA
Customer Service Toll Free 1-855-880-7205
Monday through Friday from 8:00am-5:00pm
(Eastern Time)

For additional product information, please contact our
Customer Service Center toll free at 1-855-880-7205
between 8am and 5pm Eastern Time, Monday through Friday.

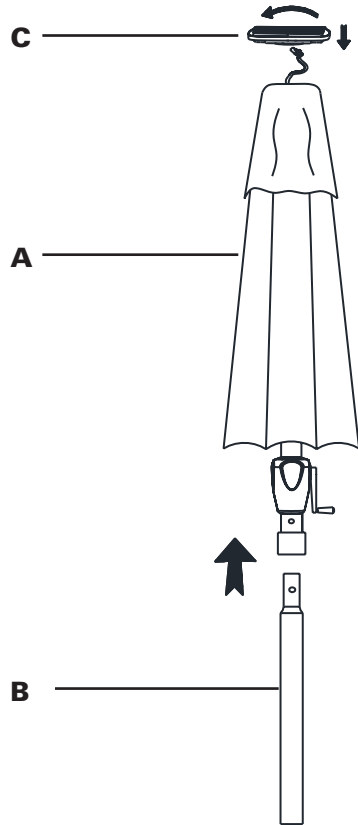

2. Package Contents |

| Replacement Parts 7.



PART	DESCRIPTION	QTY(PC)
A	Umbrella Frame with Canopy	1pc
B	Bottom Pole	1pc
C	Solar Panel	1pc

For replacement parts, call our customer service department at 1-855-880-7205, 8:00 a.m. - 5:00 p.m., EST, Monday – Friday

Description	Picture	Re-order No.
Solar Panel		SOL-P6P-T
Bottom Pole (Snap In 38mm)		BMP-38SSN-T-DMS
Canopy		CAN-9MDT8RBD-T-KH-SG-NY-SI

This ATLeisure product is covered by U.S. Patent No. 5,937,882 and U.S. Patent No. 8,104,492.

90-DAY WARRANTY

This product is covered under a manufacturer's 90-day warranty from date of purchase against defects in materials and workmanship. This warranty does not cover damage due to neglect, abuse or weather related damage. For full warranty disclosure, email us at customerservice@atleisure.com, call toll free at 1-855-880-7205 or send mail to 1040 Boulevard SE Ste. A, Atlanta GA 30312.

This warranty gives you specific legal rights, and you may also have other rights which vary from state to state.

HOW TO FILE A CLAIM

If you are within your warranty you must have your receipt and pictures of your information to send to ATLeisure at customerservice@atleisure.com, or send by mail to 1040 Boulevard SE Ste. A, Atlanta GA 30312.

6. Warnings |

WARNING: This umbrella is designed for easy operation, sunshade and decorative purposes only. It is NOT recommended that this umbrella be used during periods of high wind and rain. Always take the umbrella down during high or gusting wind and rain, when not in use and in the off-season. Failure to do so may result in personal injury and/or property damage.

Please keep children away from umbrella during assembly to avoid injury.

WARNING: If the crank becomes too hard to crank, check to see if the rope has come off the pulley. If you continue to turn the crank, the rope or crank handle could break.

CANOPY CARE INSTRUCTIONS:

Simply clean the umbrella canopy with a soft brush and mild detergent. DO NOT machine wash or dry. DO NOT iron.

AIR DRY the canopy thoroughly in an open position before storing for extended periods of time.

Note: Placement of the umbrella over or near a swimming pool will cause premature fading not covered under our warranty, especially to darker colors.

| Instructions Of Set-Up & Operation 3.

Before beginning assembly of product, make sure all parts are present. Compare parts with package contents list. If any part is missing or damaged, contact our customer service toll free at **1-855-880-7205** for replacement parts or further instructions.

Estimated Assembly Time: 10 minutes

Tools Required for Assembly: No Tools Required

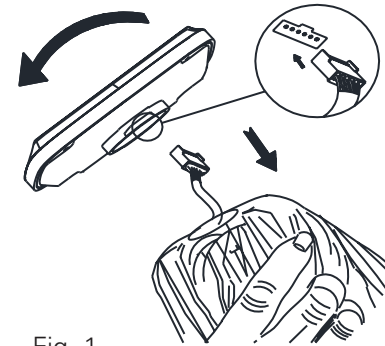

Fig. 1

Step 1. Insert the plug into the socket under the solar panel as shown in Fig. 1.

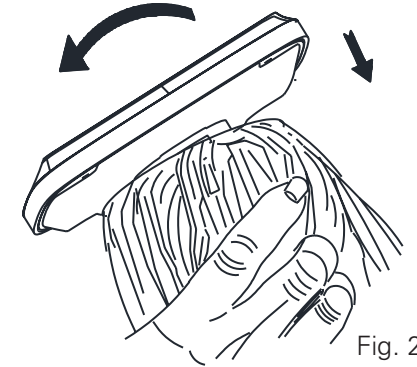

Fig. 2

Step 2. Put the solar panel on the top of umbrella and hide the plug and wire inside the groove at the top of umbrella. Then turn the solar panel clockwise. Do not over tighten. Please remove the plastic film on the solar panel. This protective plastic film is to prevent damage during shipment.

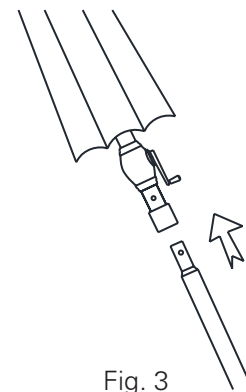

Fig. 3

Step 3. To assemble the two pole pieces together: Insert the bottom pole into the upper pole while pressing the snap button on the bottom pole until the snap button locks into position as shown in Fig. 3.

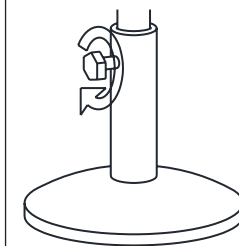

Fig. 4

Step 4. We recommend that you stand and secure the umbrella to an umbrella base (not included). Secure the umbrella pole firmly by tightening the locking nut as shown in Fig. 4

4. Instructions Of Set-Up & Operation (cont'd) |



Step 5. Put the solar umbrella in the sunlight to charge the battery before the first use as shown in Fig. 5.



Fig. 5

Make sure to charge the battery for at least 8 hours before the first use. Otherwise it will shorten lifespan of the battery and decrease performance. If charging the solar panel while attached to the umbrella, make sure the switch on the pole is in the off position.

Step 6.

(1) Turn the crank handle in the clockwise direction to open the umbrella canopy, in the opposite direction to close the canopy. **TO CLOSE THE UMBRELLA IT MUST BE IN THE UPRIGHT POSITION.**

(2) You can tilt the umbrella to your desired angle by pressing the Tilt Button to release the umbrella top. Release the button to maintain the desired angle.

(3) Press the light switch to turn on/off the solar lights.

Reverse the set-up steps above to take down the umbrella.

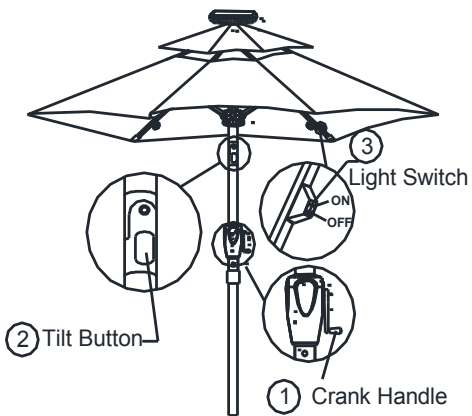

ATTENTION: You must charge battery before first use.



Please note that battery can discharge if they are left unused or uncharged for a long period of time. Since there can be a six-month period between production and final customer purchase, we recommend you charge your solar umbrella for at least 8 hours in direct sunlight before the first use. Failure to charge the battery will result in premature dimming of the lights in your new solar umbrella. Make sure the light switch is in the off position when charging the solar panel.

For everyday normal use, turn on the light switch in the night-time when you want to use solar light and turn off the switch after use. **MAKE SURE THE LIGHT SWITCH IS IN THE OFF POSITION IN THE DAYTIME FOR THE SOLAR PANEL TO RECHARGE THE BATTERY.**



NOTE: PLEASE REMOVE THE PLASTIC FILM ON ALL SOLAR PANELS, HUBS, AND LIGHTS AS THIS PROTECTIVE COATING IS TO PREVENT DAMAGE IN SHIPPING.

| How to Replace the Batteries 5.

We recommend that you change the battery in your solar light umbrella every year or when you feel the light output is diminished. For best results buy (1) 18650 Lithium 1500mAh rechargeable battery same as supplied with panel. Install only new batteries of the same type in your product. You can purchase at specialty retailers.

**Failure to insert battery in the correct polarity, as indicated in the battery compartment, may shorten the life of the battery or cause the battery to leak. Do not dispose of battery in fire. Battery should be recycled or disposed of as per state and local guidelines. Do not mix old and new batteries. Do not mix Alkaline, Standard (Carbon-Zinc) or Rechargeable (Nickel Cadmium) or (Nickel Metal Hydride) batteries.*

Tools required: Phillips head screw driver (not included).

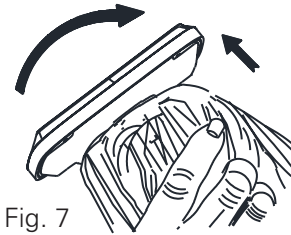

Fig. 7

Step 1. Twist counterclockwise and remove the solar panel from the top of the umbrella as shown in Fig. 7.

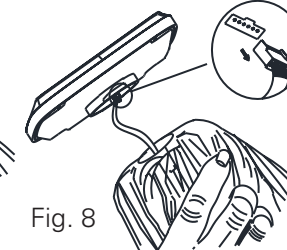

Fig. 8

Step 2. Pull the plug out of the socket under the solar panel. Pull by holding the plug, not by pulling on the wires.

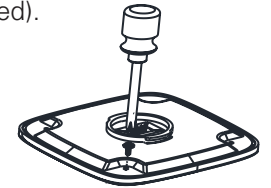

Fig. 9

Step 3. Put the solar panel upside down on a flat, non-abrasive surface to avoid scratching. Loosen all four (4) screws on the solar panel bottom case as shown in Fig. 9.

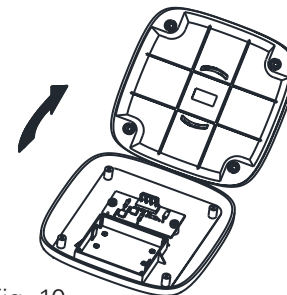

Fig. 10

Step 4. Carefully open the bottom case and set aside. 10. Replace the battery, matching the +/- on the battery with the +/- on the battery case as shown in Fig. 10.

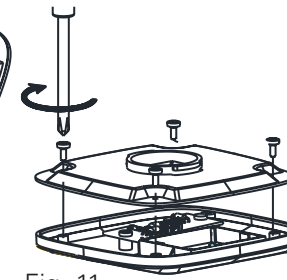

Fig. 11

Step 5. Carefully put the bottom case back. Align the screw holes and replace the screws. Do not over tighten the screws as shown in Fig. 11.

Your solar umbrella is ready to use again!

For everyday normal use, turn on the light switch in the night-time when you want to use solar light and turn off the switch after use. And make sure the light switch is in the off position in the daytime for the solar panel to recharge the battery.