

sleep  number®

Ultimate Bed Assembly Guide





50

70

## Welcome and Congratulations

Congratulations on your purchase of a SLEEP NUMBER® bed! You're about to join the more than 8 million people who've traded their innerspring mattresses for the most innovative sleep surface ever. The technology behind the *Sleep Number* bed is one that recognizes the unique sleeping needs of every individual, which vary according to comfort preference, body type, height, weight, sleeping position, and other health and lifestyle factors. By creating a fully personalized sleep surface, your new *Sleep Number* bed offers you customized comfort that can significantly improve your sleep quality.

You'll enjoy years of sleep comfort and technology in your *Sleep Number* bed. Our commitment to quality is at the heart of our manufacturing process and every *Sleep Number* bed is designed and crafted in the USA. Our focus on constant innovation, value and customer satisfaction has repeatedly earned us the Consumers Digest Best Buy award.

We thank you for your purchase and wish you years of personal comfort and restful sleep.

## Dear QVC Customer,

Congratulations! We are delighted that you purchased the SLEEP NUMBER® bed. We know you will enjoy your *Sleep Number* bed for many years!

QVC and SLEEP NUMBER are committed to providing exceptional service to you. To provide that priority service, we have established the Sleep Number® GOLD SERVICE program with a phone number, 1.800.790.9298, exclusively for QVC customers. This number will allow you to quickly reach a SLEEP NUMBER® representative.

These *Sleep Number* representatives are product specialists who are able to answer any questions you may have regarding setup, finding your SLEEP NUMBER® setting, manufacturer's warranty details, or any other product-related questions—including comfort tips. When you call, please have your QVC Order Number readily available. *Sleep Number* representatives are available Monday through Friday, 8 a.m. to 8 p.m. CST and Saturday, 8:30 a.m. to 5 p.m. CST. You can also visit the SLEEP NUMBER® customer website at [mygoldservice.com](http://mygoldservice.com), where you will find assembly information, troubleshooting FAQs and warranty information.

For all other questions, please contact QVC Customer Service at 1.800.367.9444 or visit [qvc.com/customerservice](http://qvc.com/customerservice). Thank you for your purchase. QVC and *Sleep Number* look forward to serving you in the future.

Sleep Well!

## What's Inside

Setting up your new SLEEP NUMBER® bed only takes about an hour, but you'll enjoy the benefits of better sleep for years to come. You won't need any tools and, although it's nice to have a helper, you can do it by yourself. First, you'll need to remove your old bed.

Note: If you ordered the SLEEP NUMBER® adjustable base system, please see the Sleep Number® Adjustable Base Assembly Instructions, then proceed to page 12 of this manual to complete your mattress assembly.

Modular Base Assembly.....	pg 6
Mattress Assembly.....	pg 12
Firmness Control™ System .....	pg 20
Product Care .....	pg 23
Warranty and Notification.....	pg 24
Frequently Asked Questions .....	pg 26



# Important

- Decide where to put your new bed
- Make sure there's an electric power source nearby to operate your Firmness Control™ system
- IMPORTANT: Use a surge protector
  - While the Firmness Control™ system may be plugged directly into a wall outlet, we recommend using a surge protector to guard against unexpected power surges. Please note: Your Limited Warranty does not cover damage to the Firmness Control™ system due to a power surge, regardless of the source. See the Limited Warranty on page 24 for more details.
- Open all boxes
  - CAUTION: Immediately dispose of packaging as it can pose choking or other hazards to small children and pets.
- IMPORTANT NOTE: Prepare your foam layer(s)
  - a. Locate box with foam comfort layer(s)
  - b. Carefully open the foam comfort layer(s) and set aside. At least 30 minutes of expansion time is needed
- Firmness Control™ system
  - a. Locate box with Firmness Control™ system
  - b. Set Firmness Control™ system aside. It will be required later during modular base assembly



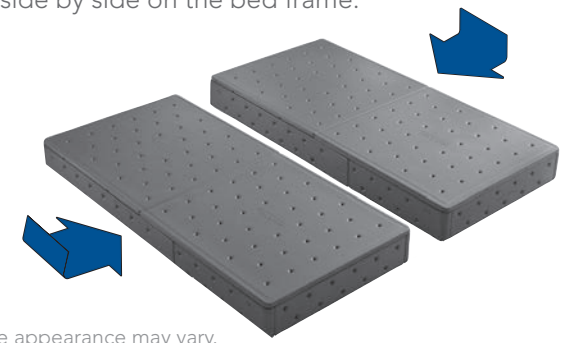

## Before You Begin Your Modular Base Assembly

- Carefully check the contents of your base boxes
  - a. Verify that you have the correct number of components required for the size of bed you purchased (see Modular Base Parts and Components list on the following page)
  - b. If you are missing any items listed on the following page, please call 1.800.790.9298 or email Customer Service at customerservice@selectcomfort.com
  - c. Familiarize yourself with all of the parts by comparing them to the images on the following page
- Prepare your bed frame, if you have one
  - Your modular base can be assembled directly onto your current bed frame or on the floor. Some bed frames have slats that run from one side of the bed to the other. If your bed frame has slats, position the slats evenly to support the base. If your bed frame has fewer than three slats, we recommend adding additional slats to ensure adequate support.
  - NOTE: Be sure the size of your base corresponds to the size of your bed frame. To ensure adequate support, check your frame for center support. If the frame does not have center support, we recommend the use of bed slats.
- King bases
  - King and California King bases consist of two bases side by side, as shown below. Complete the assembly of one unit, assemble the second, then place side by side on the bed frame.

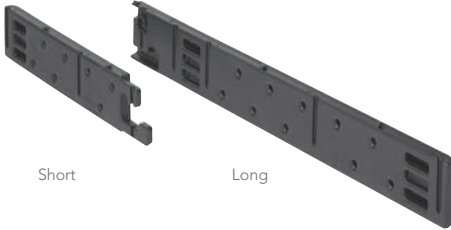
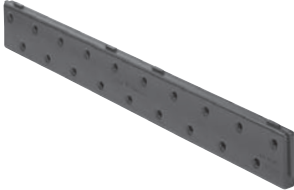
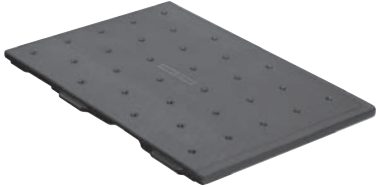

Note: Texture and surface appearance may vary.

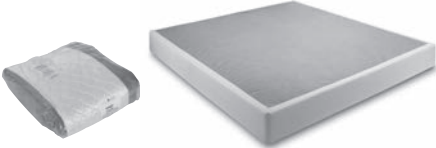
# Modular Base Parts and Components

		Full	Queen	King/ California King
<p><b>Side Rails</b></p> <p>Texture and surface appearance may vary</p>		2 Short 2 Long	2 Short 2 Long	4 Short 4 Long
<p><b>Support/End Beams</b></p> <p>Texture and surface appearance may vary</p>		6 2 labeled "End Beam" 4 labeled "Support Beam"	6 All labeled "Support Beam"	12 King: all labeled "Support Beam" California King: 4 labeled "End Beam" 8 labeled "Support Beam"
<p><b>Deck Panels</b></p> <p>Texture and surface appearance may vary</p>		4	4	4
<p><b>Pin Components</b></p>		2	2	4
<p><b>Coverlet</b></p> <p>Packaged in the mattress box</p> <p>Shown as packaged</p>		1	1	1
<p><b>Firmness Control™ System</b></p> <p>Remote(s) will vary</p>		1	1 2 remotes included. 1 remote for single chamber bed.	1 2 remotes included

## 1 Side Rails

- Connect the short and long side rails
- Push firmly; joints fit tightly

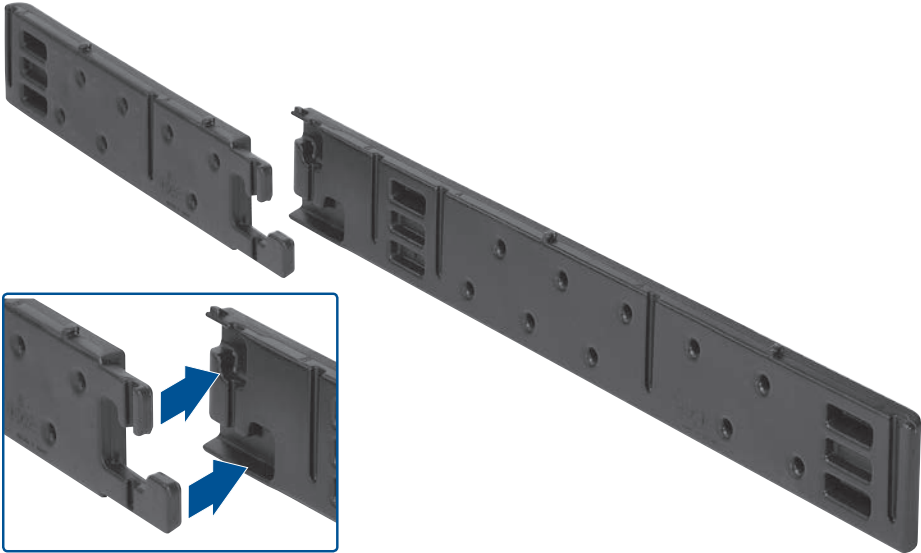

## 2 Pins

- Insert pins by sliding into side rails in the direction of the arrow
- Push firmly
- Make sure that the top of the pin is flush with the top of the side rail as shown in image "B" below

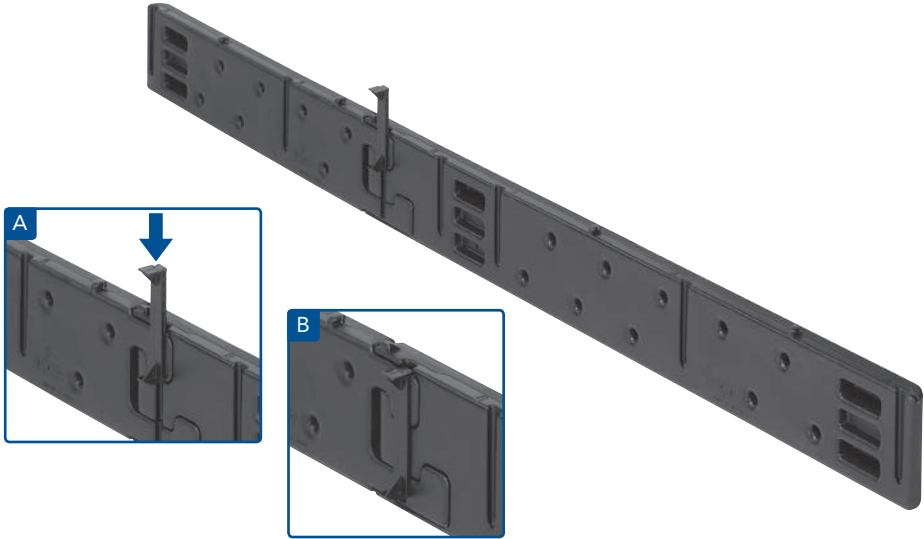



### 3 Support/End Beams

Match "A" end of the support/end beam with the "A" groove of the side rail. Match "B" end of the support/end beam with the "B" groove of the side rail

For Queen and King beds:

- Slide one of the beams labeled "support beam" into the end of the side rails at the head of the bed, ensuring the tabs are pointed up; push firmly until top is flush; joints fit tightly
- Slide remaining support beams into grooves of the side rails, beginning at the head of the bed and progressing toward the foot. Be sure to match the "A" end of the support beam with the "A" groove of the side rail and the "B" end of the support beam with the "B" groove of the side rail

For Full and California King beds:

- Slide one of the beams labeled "end beam" into the side rails at the head of the bed, ensuring the tabs are pointed up; push firmly until top is flush; joints fit tightly at the head of the bed
- Slide support beams into grooves of the side rails, beginning at the head of the bed and progressing toward the foot. Be sure to match the "A" end of the support beam with the "A" groove of the side rail and the "B" end of the support beam with the "B" groove of the side rail
- Slide remaining beam labeled "end beam" into the grooves at the foot of the bed

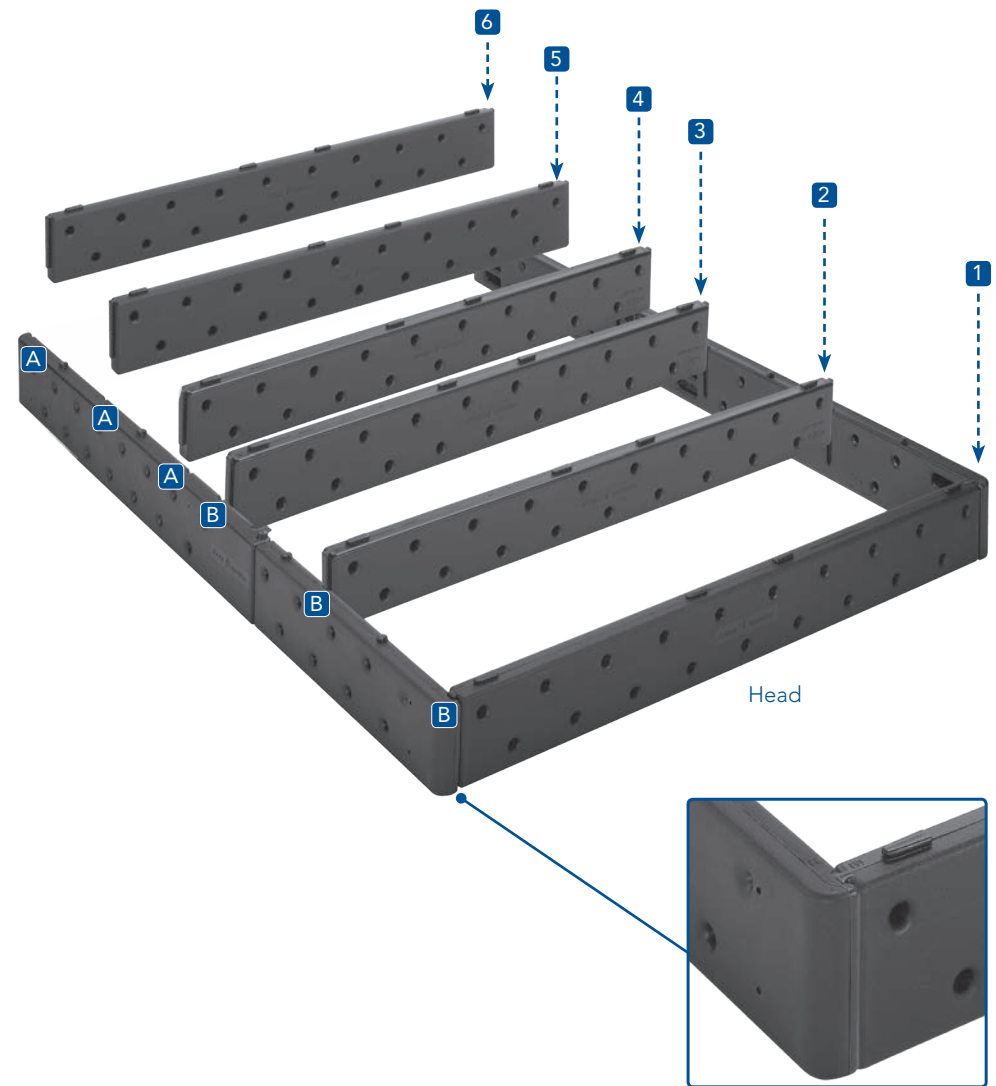

## 4 Firmness Control™ System

- Place the Firmness Control™ system under the base at the head of the bed with the hoses pointing in the direction of the head of the bed  
 CAUTION: If base is placed directly onto floor, place Firmness Control™ system next to the head of the base.
- Plug the power cord into the Firmness Control™ system and into a surge protector
- Extend hoses in front of the head of the bed and toward their respective sides of the bed (for dual chamber beds) or to one side (for single chamber beds)

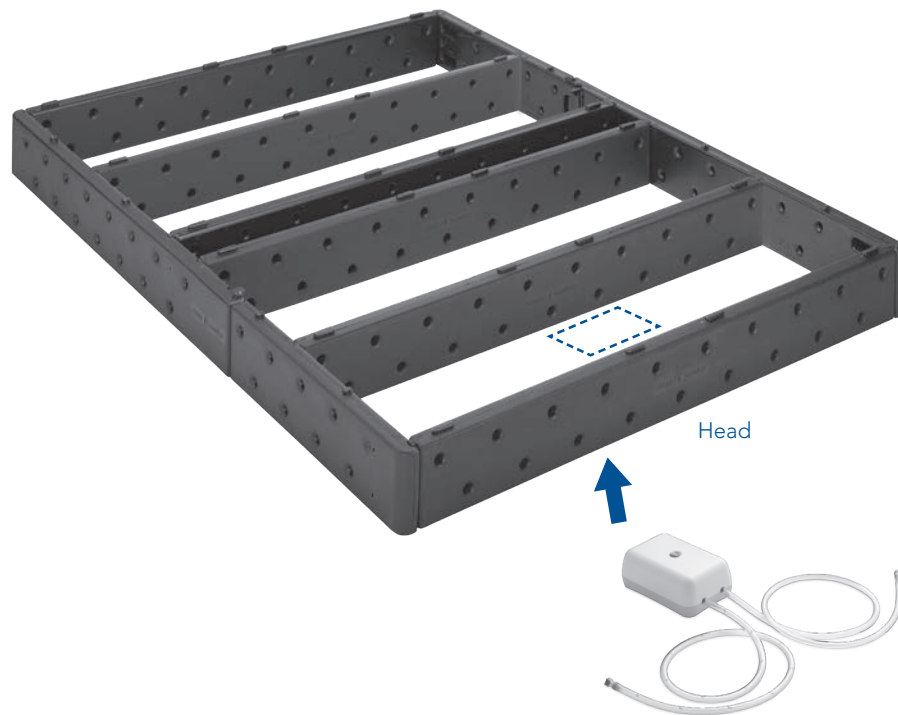

## 5 Deck Panels

- Slide deck panels onto frame from outside in, locking each deck panel into place by securing it to the tabs of the frame and beams
- Ensure the deck panels are flush on all sides
- Panels fit snugly; do not force

NOTE: King and California King bases consist of two bases, side by side. They do not connect to each other.

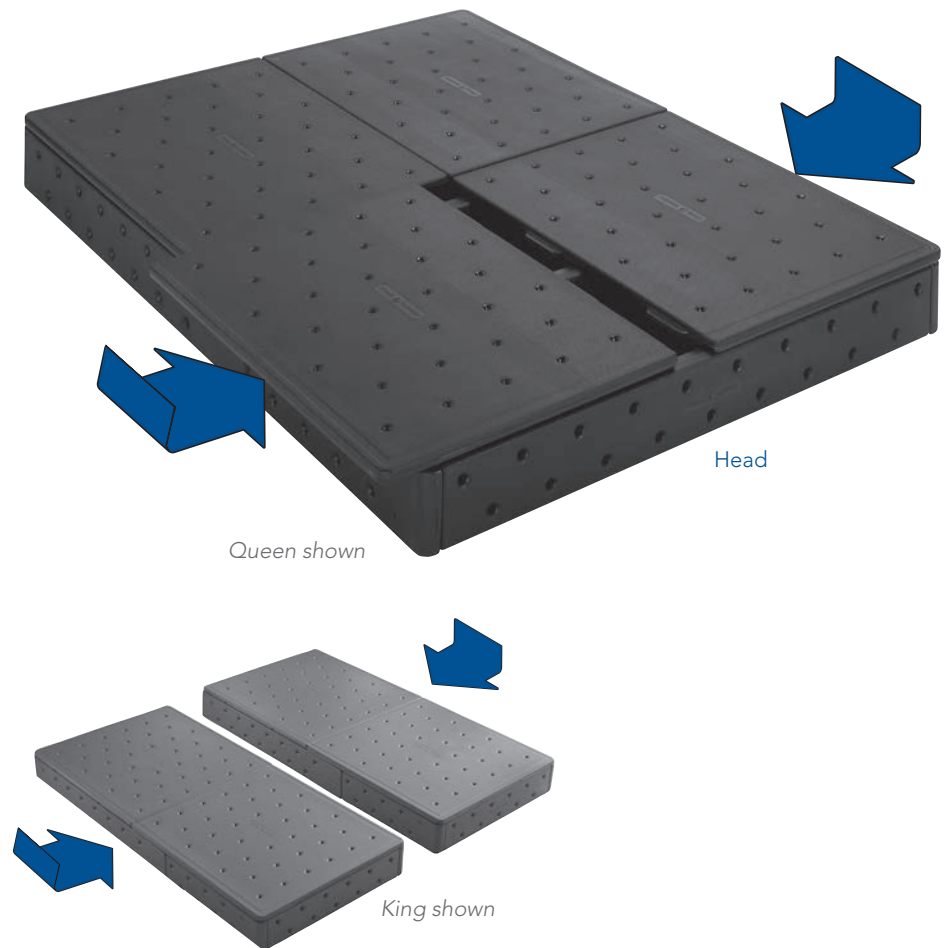

Note: Texture and surface appearance may vary.

## 6 Coverlet

- Place coverlet on top of base
- Carefully cover one corner at a time, positioning the seam at the head of the bed



# Important

- Orientation

These instructions refer to “left” and “right” as if you are lying on your back on the bed looking toward the foot of the bed

- Open all boxes

CAUTION: Immediately dispose of packaging as it can pose choking or other hazards to small children and pets.

- Carefully check the contents of your mattress boxes

- a. Verify that you have the correct number of components required for the size of bed you purchased

- b. If you are missing any items listed on the following page, please call 1.800.790.9298 or email Customer Service at customerservice@selectcomfort.com

- IMPORTANT: Use a surge protector. The warranty does not cover damage to the Firmness Control™ system due to a power surge. Using a surge protection device (not included) is recommended.

- NOTE: If you have not done so already

- a. Firmness Control™ system

- Place the Firmness Control™ system under the base at the head of the bed with the hoses pointing in the direction of the head of the bed (see page 10 for reference)

CAUTION: If base is placed directly onto floor, place Firmness Control™ system next to the head of the base.

- Plug the power cord into the Firmness Control™ system and into a surge protector

NOTE: For best results, do not plug surge protector into an outlet that’s controlled by a wall switch.

- Extend hoses in front of the head of the bed and to their respective sides of the bed (for dual chamber beds) or to one side (for single chamber beds)

- b. Prepare your foam layer(s)

- Locate box with foam comfort layer(s)

- Carefully open the foam comfort layer(s) and set aside. At least 30 minutes of expansion time is needed

CAUTION: Immediately dispose of packaging as it can pose choking or other hazards to small children and pets.



# Mattress Parts and Components

		Full/ Single Queen	Dual Queen/King/ California King	Split King
<p><b>Mattress Cover</b></p> <p>Color and pattern will vary by bed</p>		1	1	2
<p><b>Foam Border Walls</b></p> <p>Two long and two short</p>		4	4	8
<p><b>Air Chambers</b></p>		1	2 May be in one package	2 May be in one package
<p><b>Firmness Control™ System with Remote(s)</b></p> <p>Remote(s) will vary</p>		1	1 2 remotes included	1 2 remotes included
<p><b>Center Foam Wall</b></p> <p>Dual chamber beds only</p>		0	1	0
<p><b>Foam Comfort Layer</b></p> <p>Color and pattern will vary by bed Shown as packaged</p>		1	1	2

## 1 Mattress Cover

- Place mattress cover on base or on existing bed platform

NOTE: Make sure the openings in the bottom of the mattress cover are at the head of the bed.



## 2 Mattress Cover Top

- Unzip and set mattress cover top aside

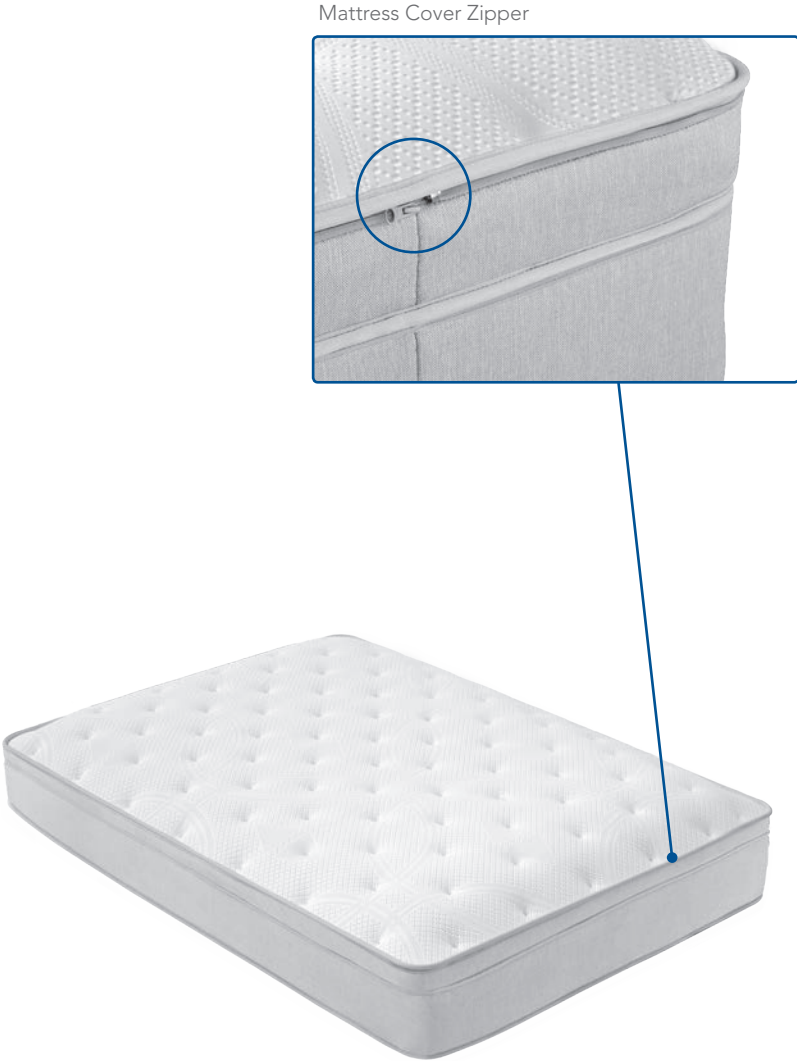

### 3 Foam Side Walls

- Place long border walls along inside of mattress cover, extending the entire length of the bed
- Ensure that the notches are facing the center of the bed



### 4 Foam End Walls

- Place short border walls at the head and foot inside the mattress cover, between the side walls
- Make sure the foam border walls are connected securely and squarely
- Ensure that the zipper is aligned with the top edge of the foam border walls

NOTE: It is okay if the foam walls bow to the inside of the bed at this point in the assembly.



## 5 Air Chamber(s)

- Place air chamber(s) in the bottom of the mattress cover so the hose connectors lie on the bottom when inflated and the connectors face the head of the bed

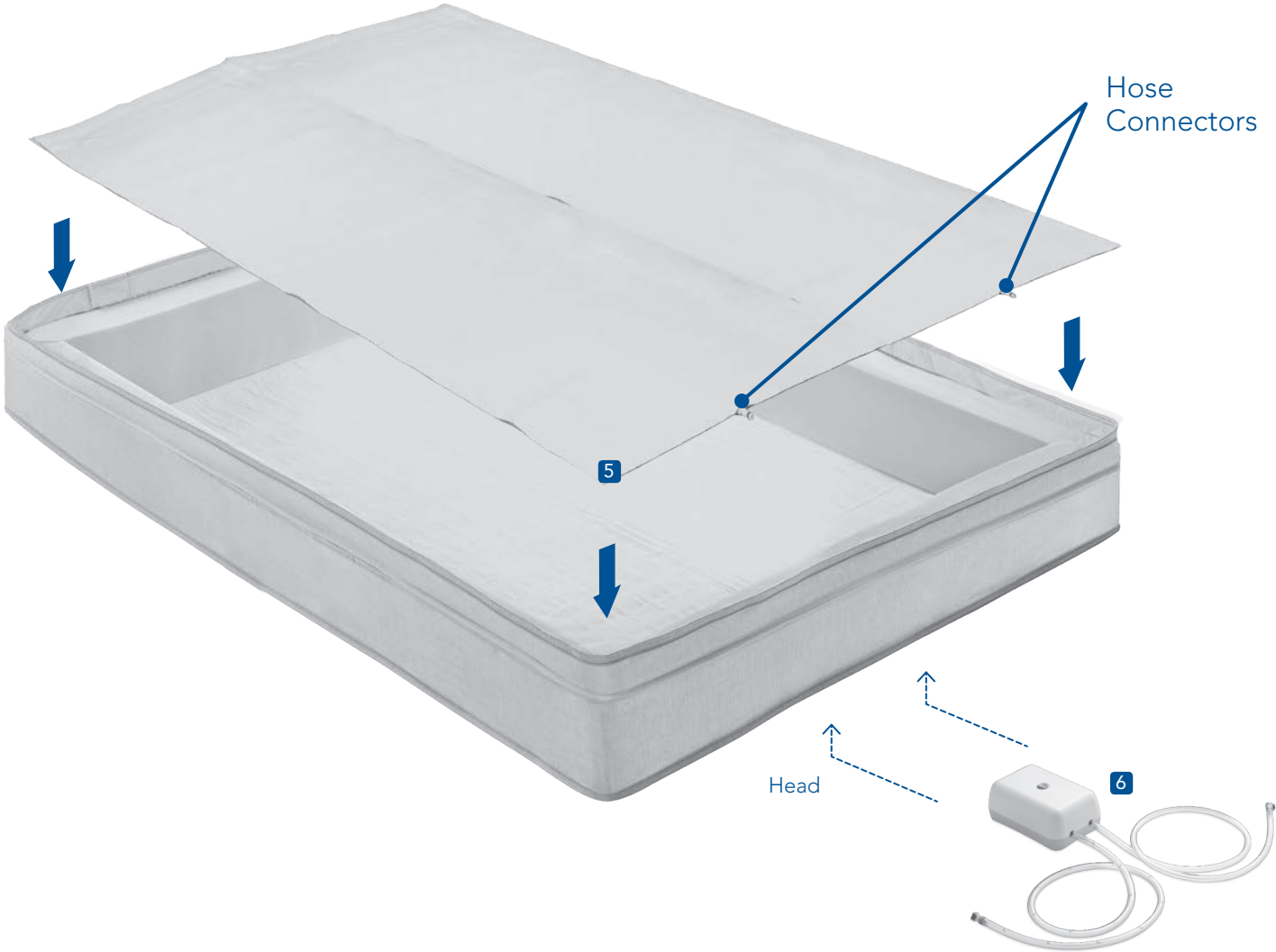

Dual chamber bed shown.



Store air chamber caps inside mattress at head of bed.



## 6a Firmness Control™ System for Dual Chamber Beds

- Locate the hoses for the Firmness Control™ system
- Pass the hose marked "L" through the opening on the left side of the mattress cover. Connect the hose to the left air chamber by pushing together until you hear a click. (Left is indicated as though you are lying on your back on the bed, looking toward the foot of the bed)
- Repeat with the unmarked hose and remaining air chamber
- Unplug and re-plug your Firmness Control™ system into a surge protector
- While standing next to the bed, choose L or R to initiate one side of the bed, and then press and hold the firmer ▲ arrow to reach a SLEEP NUMBER® setting of 50
- Repeat on the other side with the remaining air chamber

## 6b Firmness Control™ System For Single Chamber Beds

- Locate the hose for the Firmness Control™ system
- Pass the hose through the opening in the mattress cover and connect to the air chamber by pushing together until you hear a click
- Unplug and re-plug your Firmness Control™ system into a surge protector
- While standing next to the bed, press and hold the firmer ▲ arrow to reach a SLEEP NUMBER® setting of 50

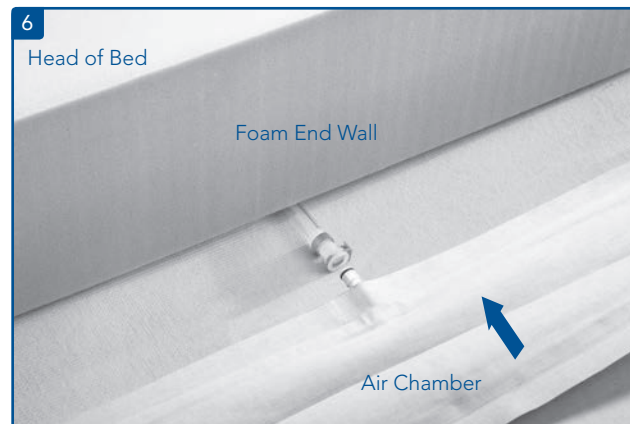

## 7 Center Foam Wall (Dual Chamber Beds Only)

- Insert center foam wall between the air chambers

Center Foam Wall



## 8 Foam Comfort Layer\*

- Place the textured foam comfort layer on top of the air chamber(s), ensuring smooth side is facing down



\*Foam color and pattern may vary.

## 9 Border Wrap

- Ensure that the border wrap extends over the foam comfort layer as shown below

**Important Safety Notice:** To ensure compliance with federal flammability requirements, the border wrap must be positioned correctly within the mattress as shown.

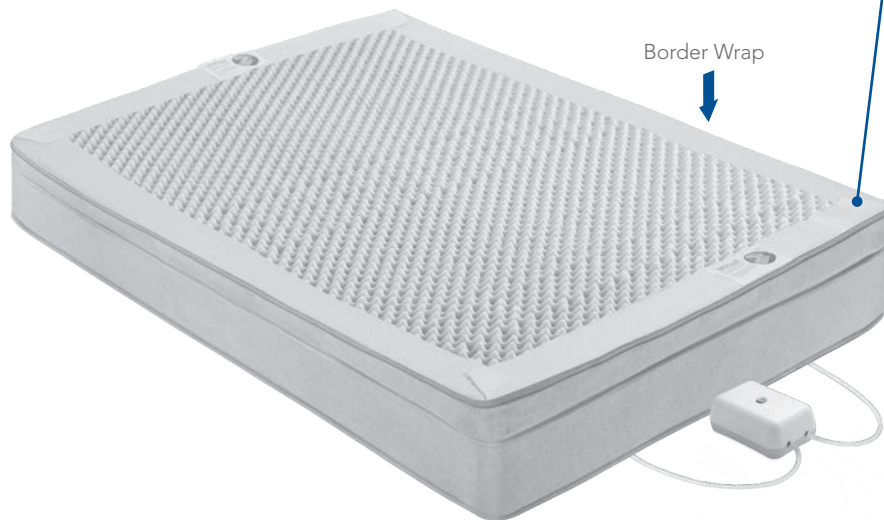
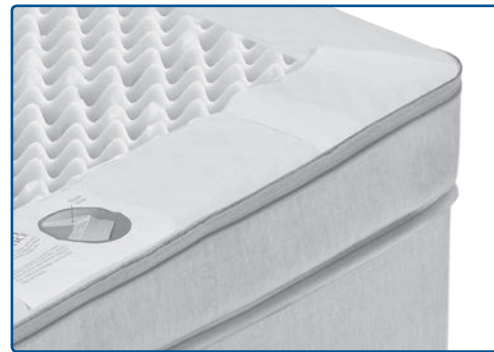

## 10 Mattress Cover Top

- To close mattress cover, place mattress cover top on bed and ensure zipper pull is at head of bed
- Make sure the zipper pin is completely inserted into the zipper box. Zip the top of the mattress cover closed

Proper zipper alignment

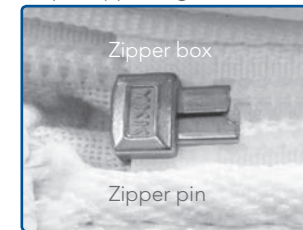

# Your Remote and Its Functions

## Single Chamber

(wakes when any button is pressed)

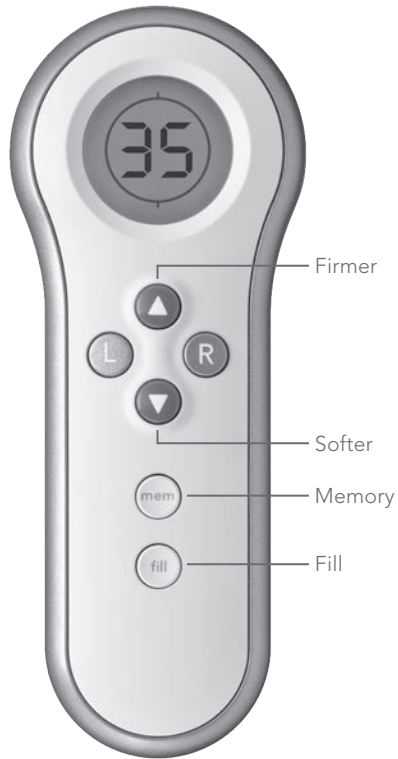

## Dual Chamber

(wakes when L or R button is pressed)

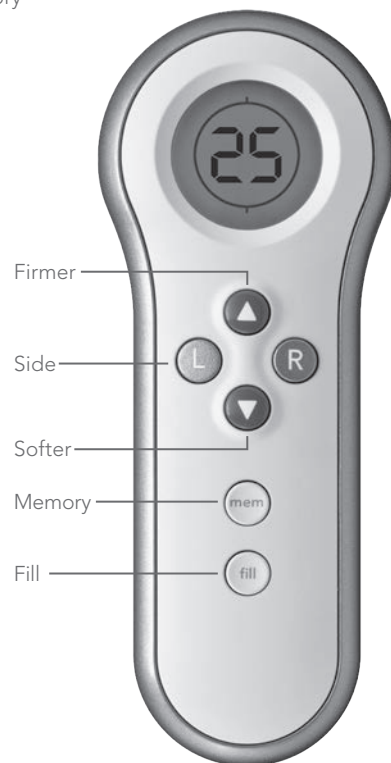

Button	Function
Side (L) and (R)	Press to choose a side; it will display the previous SLEEP NUMBER® setting.
Firmer ▲ Softer ▼	Press and release the ▲ or ▼ button several times until desired <i>Sleep Number</i> setting is displayed. Adjustment will begin after a slight delay.
Memory	<p>The memory feature allows you to set your favorite <i>Sleep Number</i> setting into memory and recall it at any time.</p> <p><b>SETTING MEMORY</b></p> <ul style="list-style-type: none"> <li>- Press L or R to choose a side and wake up the remote</li> <li>- Adjust the bed to the <i>Sleep Number</i> setting you'd like as your memory setting</li> <li>- Press and hold the Memory button for 3 seconds</li> <li>- "Memory Set" will appear above the <i>Sleep Number</i> when it's set</li> </ul> <p><b>RECALLING MEMORY</b></p> <ul style="list-style-type: none"> <li>- Press L or R on the side you would like to recall</li> <li>- Press the Memory button 2 times within 5 seconds</li> </ul> <p>The first press of the button will display the current <i>Sleep Number</i> set in memory. The second press of the button will adjust the bed to the memory setting. As the adjustment is taking place, the number displayed and tick marks will indicate the change.</p>
Fill	<p>The fill feature allows you to inflate one or both chambers to a <i>Sleep Number</i> setting of 100</p> <ul style="list-style-type: none"> <li>- To fill both chambers press and hold the Fill button for at least 2 seconds</li> <li>- To fill one chamber press any button to wake up remote, then press L or R to select a side. Then press and hold Fill button for at least 2 seconds.</li> </ul> <p>To stop the fill feature at any time, press any button on the remote.</p>

A 9-Volt battery is included and should last about six months under normal use. Replace the battery when the low battery indicator is displayed.

For more information on your remote see pages 26-27.

# Sleep Number® Setting

## What Is a Sleep Number® Setting?

Your SLEEP NUMBER® setting is a setting between 5 and 100 that represents the ideal combination of mattress comfort, firmness, and support for your body, allowing you to have more deep, restorative sleep.

## Your Sleep Number® Setting

When you shopped for the SLEEP NUMBER® bed, you may have discovered your *Sleep Number* setting. You should use this as a starting point when setting the firmness of your SLEEP NUMBER® mattress. If you don't already have your *Sleep Number* setting, or if you would like to experiment with finding a different *Sleep Number* setting, use the instructions below.

## Find Your Sleep Number® Setting

**Step 1 — Ready** - Lie down in your favorite sleeping position and adjust your pillow to your liking. Using your remote, change your *Sleep Number* setting to 100 (firmest), and then down to 20 (very soft).

**Step 2 — Set** - Next, set your *Sleep Number* setting back to 100. As the mattress gets firmer, how do your neck, shoulders, hips and back feel? When you feel comfortably supported, stop by pressing the firmer ▲ or softer ▼ button. Make adjustments up or down by increments of 5-10.

**Step 3 — Sleep** - Try sleeping at this setting for 3-5 nights. If you need to make an adjustment, change your setting by 5-10 and try this new setting for 3-5 nights.

## Evaluating Your Comfort Level

As you are customizing the *Sleep Number* bed for your optimal comfort level, you will want to evaluate your sleep position and determine how you feel as compared to the diagrams shown to the right, then make adjustments to your firmness or pillow if needed. Your pillow should help keep your body aligned properly, otherwise it may interfere with your ability to sleep comfortably. Visit [sleepnumber.com](http://sleepnumber.com) or one of our stores to get fit for a perfect pillow and see the extensive selection of innovative pillows we carry for all sleep positions and fill preferences.

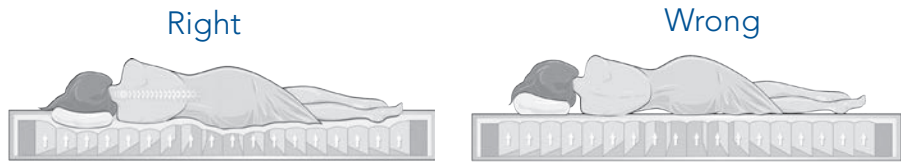

- Neck and back are aligned in the same position as when you are upright
- Shoulder and hip pressure points are relieved
- You feel the mattress support the small of your back (back sleepers) or the curve of your side (side sleepers)

- Body alignment is not straight
- Your pillow makes your head tilt at an angle to the rest of your body
- Pressure at your neck, shoulders, back, hips or legs may cause discomfort

## Give It Time

Sometimes it takes a little while to discover your ideal *Sleep Number* setting. When you have found a *Sleep Number* setting where you feel comfortable, try it for three to five nights. After five nights, reevaluate your comfort level and only adjust the setting in increments of 5-10. Repeat the process until you have found the perfect setting for you.

If after trying four different *Sleep Number* settings you have not found your ideal *Sleep Number* setting and would like additional assistance, visit [sleepnumber.com](http://sleepnumber.com) and click on Customer Service or call 1.800.472.7185 to reach a Customer Service Representative. Our trained Customer Service Representatives will provide help to improve your comfort.

## Things to Remember

- Reasons to alter the firmness of your bed
  - strained muscles
  - back pain
  - weight change
  - pregnancy
  - sunburn
  - new sleep position

as well as

- to facilitate getting out of bed, if needed
  - to achieve a fuller bed appearance
- Dual Adjustability
 

If you purchased a dual chamber bed, you have the ability to personalize each side of your SLEEP NUMBER® bed. Since no two body types are the same, each sleep partner should find their own comfort level.

If your bed came with one remote for a dual chamber bed, the “L” button on the remote corresponds to the left side of the bed (left is determined when lying on your back on the bed, looking toward the foot of the bed). The “R” button corresponds to the right side.

## Sleep Number® Setting Study

As you can see in the chart below, *Sleep Number* bed owners find comfort at all settings from 5–100, however the majority of sleepers find their SLEEP NUMBER® setting between 35 and 50.

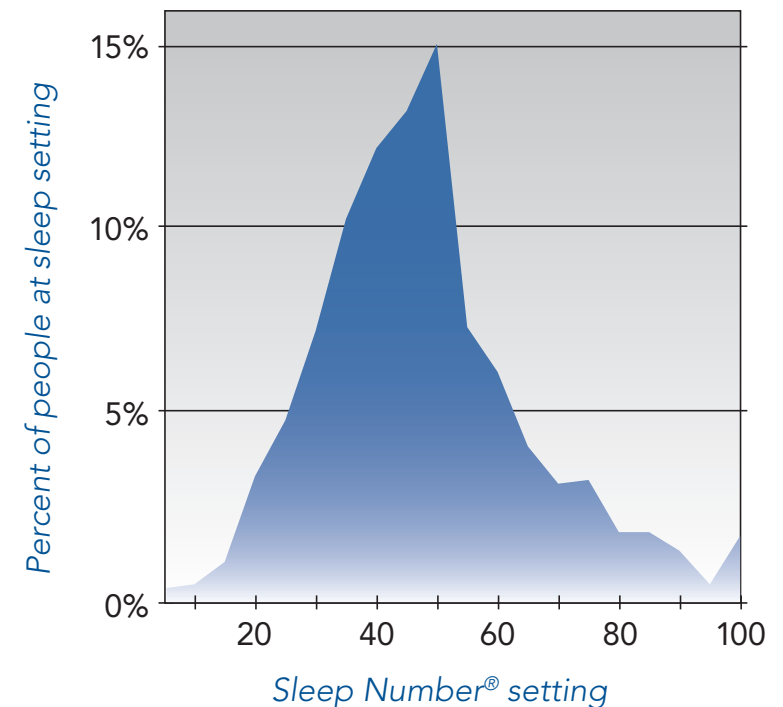

# Product Care

## Mattress Care

The cover of your SLEEP NUMBER® mattress may be spot cleaned with carbonated water. Do not dry clean the mattress cover or put it in a washing machine. Also, please do not apply stain guard, as it may cause yellowing of the fabric.

SLEEP NUMBER is a leader in the industry in the use of materials designed to inhibit the growth of allergens or microorganisms.

Advanced antimicrobial safeguards are incorporated into every SLEEP NUMBER® bed. Key components of the mattress have been treated to protect the bed from contaminants such as mold, mildew and bacteria growth. The unique, zip-open design of the *Sleep Number* bed allows you to easily open, ventilate, or vacuum if you choose.

In rare instances under the right conditions, mold or mildew can form inside many types of mattresses, bedding or upholstered products. Should this condition occur in your mattress, please contact our Customer Service department at 1.800.790.9298 so we can work with you to return your bed to factory-fresh condition.

## Remote Care

To Clean:

- Wipe body of remote with a clean cloth slightly dampened with a mild soap and water solution.
- Wipe the display screen with a clean, dry, lint-free cloth.

CAUTION: Do not immerse in water or place in dishwasher.

## Transporting Your Sleep Number® Bed

Your *Sleep Number* bed is lighter than any conventional bed, making it much easier to move.

Moving your bed

- Always disassemble the base. Bag all hardware so that it is not lost.
- The mattress can be fully inflated, capped off, and packaged in a mattress box for moving.
- If you don't have a mattress box, the cover and foam should be double-bagged to prevent stains. The air chamber(s) should be deflated and boxed to prevent possible damage.
- Pack the Firmness Control™ system in a box with packing material. It should be transported with minimal exposure to shock and vibration.
- Tuck the remote, caps, and instructions in the box with the Firmness Control™ system to prevent them from being lost.

# Warranty and Notification

## Return Policy and In-Home Trial

We hope you are completely satisfied with your SLEEP NUMBER® bed, but if you are not, contact QVC at 1.800.367.9444. They will be able to provide you with further details.

In the event that replacement components are required or if you wish to upgrade to newer components that are not covered in the warranty, you may purchase these items by simply providing proof of purchase. All component sales are final and carry a 2-Year Limited Warranty from the purchase date. Product discounts and bedding promotions do not apply to components. For current pricing and to process a component purchase, call our Customer Service department at 1.800.790.9298.

## Sleep Number® Mattress and Modular Base Limited Warranty

Select Comfort Corporation ("Sleep Number") warrants this mattress and/or mattress base against defects in material or workmanship to the original purchaser for a period of twenty-five (25) years from the date of original purchase or invoice, whichever is later.

**WHAT WE WILL DO:** At our option, *Sleep Number* will repair or replace the warranted product or part provided that it is returned to us as provided herein. During the first two (2) warranty years, any covered repairs or replacement parts will be at no cost to you. *Sleep Number* reserves the right to substitute products or parts of comparable quality and value or, where permissible by law, to use or deliver refurbished products or parts in the repair or replacement of any product or part that does not come into contact with the sleep surface (e.g. the Firmness Control™ system or the air chambers) under this limited warranty.

**HOW WARRANTY COVERAGE IS CALCULATED:** During the following warranty years, your repair or replacement cost will be calculated by adjusting our then-current prices for the product or part (or a comparable product or part if the original product or part is no longer in production) as follows:

Warranty Year	Original Purchaser's Percent of Product/Part Cost
0-2	No Cost
3-20	20% plus 4% for each completed year from original purchase or invoice date, whichever is later
21-25	96%

**WHO THIS WARRANTY PROVIDES COVERAGE TO:** Your warranty is non-transferrable and sale, transfer or disposal of the warranted product or part will void this warranty. For the purposes of this warranty, an "original purchaser" is an individual who purchases the product directly from *Sleep Number* or an authorized reseller for personal, consumer use and not with the intent to resell the product or use for commercial purposes. This warranty does not apply to products purchased either with the intent to resell or through unauthorized resellers including, without limitation, third party websites such as Craigslist, eBay, or Amazon. If you are not the original purchaser, you take the product "as is" and with any and all faults.

**CLAIMS THIS WARRANTY DOES NOT COVER:** Your warranty excludes claims for conditions arising from normal wear and tear including but not limited to mattress cover compression, foam compression, discoloration of parts or normal body indentations. This warranty does not provide coverage for claims related to comfort preference (e.g., "The bed feels too hard/soft."). The warranty does not provide coverage and will become void if claims are a result of damage caused by tampering with or modifications to any component including the opening of the Firmness Control™ system or remote control. Damage caused from laundering or dry-cleaning the product or any part as well as damage caused by misuse or abuse including but not limited to stains, soil, burns, cuts, tears or spills or factors other than a product defect are also excluded under and will void this warranty. Lastly, this warranty does not provide coverage and will become void if damage is caused by acts of nature or relating to forces outside Select Comfort's control including but not limited to fire, flood or lightning damage or from damage caused by power surges. This warranty does not apply to beds sold as floor models or "demos." Changes in barometric pressure can impact the feel of your SLEEP NUMBER® mattress and may require you to occasionally adjust your Firmness Control™ system to return to your preferred SLEEP NUMBER® setting. This is normal, is a function of the environment, and does not reflect any defect in your *Sleep Number* mattress or Firmness Control™ system. Consequently, this warranty will not cover claims caused by changes in barometric pressure.

**COSTS THIS WARRANTY DOES NOT COVER:** In connection with your warranty claim, you are responsible for returning the warranted product or part to us. If your claim occurs during the first two warranty years, we will incur both the cost of shipping the warranted product or part back to us as well as the cost of our shipment of any repaired or replaced product or part back to you. If your claim occurs after the first two warranty years, shipping of products or parts related to your warranty claim will be at your expense in both directions. In either case, you remain responsible for bringing your authorized return to your nearest UPS facility or drop-off location. This warranty does not provide coverage for or the cost associated with the transportation, inspection, removal or installation of any product or parts except as provided above. The responsibility for the installation of any product or part replaced under this warranty and any related installation costs are yours regardless of whether there is any cost to you for the repaired or replaced product or part.



#### WHAT YOU MUST DO TO KEEP THE WARRANTY IN EFFECT:

**KEEP YOUR ORIGINAL RECEIPT.** You may be required to provide your original receipt at the time of any warranty claim.

**USE AN APPROPRIATE FOUNDATION.** Your SLEEP NUMBER® mattress is designed to work on a firm, solid, non-spring foundation or adjustable bed base that is sufficiently strong and stable so as being capable of supporting the weight of the mattress and its occupants. Failure to use an appropriate foundation will void your warranty.

**DO NOT REMOVE THE LAW LABEL.** Do not remove the law label attached to your *Sleep Number* mattress. This label identifies your mattress as being a genuine *Sleep Number* mattress and may be required to establish warranty coverage.

**KEEP THE MATTRESS AND/OR BASE IN A SANITARY CONDITION.** This warranty shall not apply to any product or part found to be in an unreasonably unsanitary condition. A product is in an unreasonably unsanitary condition if it is so pervasively soiled that an inspection is unable to be conducted due to the presence of body fluids, blood borne pathogens, insects or other substances that otherwise suggest that the product has been subjected to misuse or abuse beyond ordinary wear and tear.

**WHAT IS THE WARRANTY ON REPAIRED OR REPLACED PRODUCTS OR PARTS?** No new warranty is provided with any mattress or any component part that is repaired or replaced under this warranty. The warranty for any replacement mattress or component part runs from the date of your original purchase or invoice date, whichever is later. Any mattress or component part that is replaced under this warranty will be required to be returned to SLEEP NUMBER at the time of replacement.

**WHERE DOES THIS WARRANTY APPLY?** Your warranty provides coverage for products purchased and used in the United States excluding its territories and possessions (e.g., Guam, Puerto Rico and the Virgin Islands). It is not applicable to claims for products purchased or used in any other country.

**WHAT ARE THE LIMITATIONS ON THIS WARRANTY?** Your exclusive remedy, in lieu of all incidental, special or consequential damages, including for negligence, is limited to repair or replacement of any product or component deemed to be defective under the terms and conditions stated in this warranty. SLEEP NUMBER SHALL NOT BE LIABLE IN ANY CASE FOR INCIDENTAL OR CONSEQUENTIAL DAMAGES RESULTING FROM THE USE OF THIS PRODUCT OR ARISING OUT OF ANY BREACH OF THIS WARRANTY EVEN IF IT HAS BEEN ADVISED OF THE POSSIBILITY OF SUCH DAMAGES.

**ARE THERE ANY IMPLIED WARRANTIES?** EXCEPT TO THE EXTENT PROHIBITED BY APPLICABLE LAW, ANY IMPLIED WARRANTY OF MERCHANTABILITY OR FITNESS FOR A PARTICULAR PURPOSE APPLICABLE TO YOUR SLEEP NUMBER® MATTRESS AND/OR BASE IS LIMITED IN DURATION TO TWO YEARS. EXCEPT AS OTHERWISE MAY BE REQUIRED BY LAW, THERE ARE NO OTHER EXPRESS OR IMPLIED WARRANTIES OTHER THAN THE WARRANTY DESCRIBED HEREIN. *Sleep Number* does not make any warranty and specifically disclaims any warranty that your *Sleep Number* mattress and/or base is suitable for your particular medical condition. No express or implied warranties are extended to any persons who purchased the product from anyone other than *Sleep Number* or its authorized

retailers and all such warranties are hereby excluded. *Sleep Number* does not authorize any person or entity to create for it any other obligation or liability in connection with this warranty.

**HOW STATE LAW RELATES TO THIS WARRANTY:** Some states do not allow the exclusion or limitation of incidental or consequential damages or limitations on how long an implied warranty lasts so the foregoing limitations may not apply to you. This warranty gives you specific legal rights. You may also have other rights. These rights may vary from state to state.

**HOW TO FILE A WARRANTY CLAIM:** You must contact our Customer Service department at the phone number printed on the back cover of your owner's manual to obtain a Return Merchandise Authorization (RMA) number prior to returning any products or parts to us. You may be asked to undertake certain steps to troubleshoot the product or part for which a claim is being made. These steps are essential to determining whether your warranty claim is covered and ensuring shipment of the correct replacement product or part. Products or parts returned to us without an RMA will be destroyed and no warranty claim will be honored. You may also contact us by email at [customerservice@selectcomfort.com](mailto:customerservice@selectcomfort.com) or in writing to: Sleep Number Customer Service, 9800 59th Avenue North, Minneapolis, MN 55442.

## Firmness Control™ System Notification

This device complies with Part 15 of the FCC Rules. Operation is subject to the following two conditions: (1) this device may not cause harmful interference, and (2) this device must accept any interference received, including interference that may cause undesired operation. To comply with the FCC RF exposure compliance, no change to the antenna or device is permitted. Any change to the antenna or device could result in the device exceeding the RF exposure requirement and void user's authority to operate the device.

#### Important Safety Instructions:

- Your SLEEP NUMBER® bed is intended for in-home, non-commercial use only. Any unintended use voids the limited warranty.
- The remote is not a toy and should be used under adult supervision.
- Do not open the Firmness Control™ system or remote(s) (with the exception of the battery compartment). The warranty is void if these units are tampered with.
- Keep the Firmness Control™ system and remote(s) away from heat sources such as radiators, heat registers, etc.
- The Firmness Control™ system and remote(s) are not water resistant. Do not use or store near water – for example, in a wet basement, near an open window, etc.

# FAQ'S

## Modular Base FAQ'S

### Q. What if I can't get my support beams flush with the side rails?

A. Make sure the letter on the support beam matches the side rail. For example, the end of the support beam labeled "A" should connect to the side rail with the "A" on it. Additional force may be required.

### Q. How can I get my pins in all the way?

A. Insert pins by sliding into side rails in the direction of the arrow. Make sure that the top of the pin is flush with the top of the side rail.

### Q. What can I do if I can't get the deck panels to lie flat?

A. First, make sure all the pins and beams are flush. Then, set the deck panel over the notches. You should then be able to slide the panel inward into place.

### Q. Where is the hardware for the footboard and headboard brackets?

A. The same hardware for attaching the legs to the base is used for attaching the brackets (sold separately).

## Mattress FAQ'S

### Q. Where are the caps for air chamber(s)? And where should I store them?

A. The caps are in the Firmness Control™ system box. Please store these in the mattress cover in case you should ever want to disassemble your bed and temporarily cap your air chamber(s).

### Q. What if my foam comfort layer appears to be too small or irregular?

A. Gently shake the layer as you place it on your mattress and it will recover its full size overnight.

### Q. What if I feel like I'm rolling toward the edge or toward the center of the mattress?

A. Although rare, these sensations could potentially be experienced if one side of the mattress is set quite firm and the other side quite soft. Call Customer Service at 1.800.790.9298 for a remedy to this situation if it is bothersome to you.

### Q. What if I notice a rubber smell from the air chamber(s)?

A. The odor you may smell is normal and will fade over time. To minimize the smell, unzip the mattress cover and allow the air chamber(s) to air out for a few hours. Laying a couple of dryer sheets on top of the air chamber(s) will also help mask any odor by adding a fresh scent.

### Q. Why are there body impressions on the mattress cover?

A. For the best looking, most crisp appearance, customers should fully inflate the mattress.

Body impressions in a normal innerspring mattress would be an indication that the spring support is compressing or breaking down. The SLEEP NUMBER® bed uses air to support your body. Since air cannot break down, you receive the same air chamber performance after years of use as you do on the first day of use.

## Firmness Control™ System FAQ'S

### Q. Why does my Sleep Number® setting change?

A. There are several factors that can contribute to fluctuations in a SLEEP NUMBER® setting. A *Sleep Number* setting is based on the combination of body weight, volume of air in the air chamber and sleep position.

- Temperature: An increase or decrease in temperature can cause changes in a *Sleep Number* setting. For example, a heated mattress pad will cause the *Sleep Number* setting to increase.
- Barometric Pressure: Changes in atmospheric pressure related to weather and altitude can cause your *Sleep Number* setting to change.
- Weight: The Firmness Control™ system acts similarly to a scale; more weight means a higher *Sleep Number* setting. In addition, the way that the weight is distributed will affect the reading.
- Sleep Position: The more concentrated the weight is, the greater chance the *Sleep Number* setting will be higher (i.e., when you lie on your side). When it is distributed throughout the chamber more, it is more likely that the *Sleep Number* setting will be lower (i.e., when you lie on your back or stomach).

### Q. What do I do if the Firmness Control™ system doesn't run?

A. Make sure the power cord is securely plugged into the Firmness Control™ system and the wall outlet. Check to see if the power cord is plugged into an outlet that has power and is not connected to a wall switch.

### Q. I feel the mattress is losing air. What should I do?

A. Air loss can be caused by an unsecured hose connection, a defective air chamber, or a defective Firmness Control™ system. First, make sure the air hoses are securely connected to the air chambers. If you do not find any damaged or loose connections, then please identify which of the following situations matches your situation and follow the instructions for remedying your issue.

NOTE: To avoid variations in your *Sleep Number* setting or level of comfort, make sure that you are lying in your normal sleep position when adjusting and checking your *Sleep Number* setting.

If you have a dual air chamber bed and suspect only one side of your SLEEP NUMBER® bed is getting softer...

- Inspect the o-ring and connectors for cracking or damage.
- Switch the air hoses on the air chambers so the Left hose (labeled L on the Firmness Control™ system hose) is attached to the Right air chamber and the Right hose (no labeling on the hose) is attached to the Left air chamber. You should hear a click when the air hose is securely connected to the air chamber.
- Fill the air chambers to the appropriate *Sleep Number* setting(s) for the person sleeping on each side of the bed.
- Sleep on the bed and monitor the feel of the bed's firmness on both sides.
- If neither chamber feels softer over time, you may have had a loose connection that was fixed during the switching of hoses. Switch the hoses back to their correct positions and continue to use the bed as normal.
- If an air chamber feels softer after switching air hoses, please contact Customer Service with the results (the issue stayed on the same side of the bed or it moved to the other side after switching hoses).

If you have a dual air chamber bed and both air chambers are getting softer or have a single air chamber bed and feel the air chamber getting softer...

- Inspect the o-ring and connectors for cracking or damage then reconnect the Firmness Control™ system to the air chamber(s).
- Lie down in your normal sleep position and fill the air chamber(s) with suspected air loss to your normal *Sleep Number* setting plus an additional 15 points (i.e., if you sleep at 35, fill to 50). We ask that you over-inflate to compensate for air that may escape in one of the next steps.
- Locate the air chamber caps that came with your bed.\*
- Remove the hose from the air chamber and quickly cap the chamber.
- Leave the air chamber(s) capped for a minimum of 48 hours.
- If the air chamber(s) become noticeably softer when capped, contact Customer Service.
- If the air chamber(s) hold air, reconnect the Firmness Control™ system and continue using the bed. The air loss issue may have been due to environmental factors or a connection issue. Contact Customer Service if the air loss issue returns after reattaching the Firmness Control™ system.

\*Caps are typically found at the head of the bed inside the mattress cover in a small plastic bag. If you cannot find the caps, they may be available at your nearest SLEEP NUMBER® store or can be requested by emailing Sleep Number at [customerservice@selectcomfort.com](mailto:customerservice@selectcomfort.com) with your request, or by calling 1.800.790.9298.

#### Q. Will my bed deflate if there is a power surge or power loss?

A. No, your mattress will maintain its firmness. To protect your Firmness Control™ system, we recommend using a surge protector.

NOTE: The warranty does not cover damage to the Firmness Control™ system due to a power surge. Using a surge protection device (not included) is recommended.

#### Q. The wireless remote is displaying "Er." What is the problem?

A. An "Er" indicates there is an error. The Firmness Control™ system may not have power, or the remote and Firmness Control™ system may have lost communication with one another.

- Make sure the Firmness Control™ system is firmly plugged into a working outlet and is receiving power. Check to make sure the outlet is not controlled by a wall switch. You will know that the unit has power if it "clicks" when you plug it in.
- Make sure that the power cord is plugged into the side of the Firmness Control™ system.
- Wait for the display to shut off (about 10 seconds). Then try to adjust the bed again.
- If the "Er" persists call Customer Service at 1.800.790.9298

## Help is just a click or phone call away

If you ever have product questions or need additional assistance obtaining optimal comfort, please visit us at:

[mygoldservice.com](http://mygoldservice.com)

or call

**1.800.790.9298**

Representatives are available  
(Central Standard Time):

Monday-Friday 8 a.m. – 8 p.m.

Saturday 8:30 a.m. – 5 p.m.

Sunday Closed

sleep  number.

9800 59TH AVENUE NORTH  
MINNEAPOLIS, MN 55442



119758

3/14

Furniture not included.

©2014 Select Comfort. SLEEP NUMBER, SELECT COMFORT and the double arrow design are registered trademarks of Select Comfort Corporation.