



HP ENVY 5660 e-All-in-One series



---

# Table of contents

<b>1 How do I?</b> .....	<b>1</b>
<b>2 Get started</b> .....	<b>2</b>
Printer parts .....	3
Control panel and status lights .....	5
Paper basics .....	8
Load media .....	11
Load original .....	15
Open the HP printer software (Windows) .....	16
Sleep mode .....	17
Auto-Off .....	18
Accessibility .....	19
<b>3 Print</b> .....	<b>20</b>
Print photos .....	21
Print documents .....	23
Print on both sides (duplexing) .....	24
Print with AirPrint .....	25
Print using the maximum dpi .....	26
Tips for print success .....	27
<b>4 Use Web Services</b> .....	<b>29</b>
What are Web Services? .....	30
Set up Web Services .....	31
Print with HP ePrint .....	33
Use HP Printables .....	35
Use the HP Connected website .....	36
Remove Web Services .....	37
Tips for using Web Services .....	38

<b>5 Copy and scan</b> .....	<b>39</b>
Copy documents .....	40
Scan .....	41
Tips for copy and scan success .....	46
<b>6 Work with cartridges</b> .....	<b>47</b>
Check the estimated ink levels .....	48
Replace the cartridges .....	49
Order ink supplies .....	51
Use single-cartridge mode .....	52
Cartridge warranty information .....	53
Anonymous usage information storage .....	54
Tips for working with cartridges .....	55
<b>7 Connect Your Printer</b> .....	<b>56</b>
Set up the printer for wireless communication .....	57
Change network settings .....	62
Advanced printer management tools (for networked printers) .....	63
Tips for setting up and using a networked printer .....	65
<b>8 Solve a problem</b> .....	<b>66</b>
Jams and paper-feed issues .....	67
Ink cartridge issues .....	72
Printing issues .....	74
Copy issues .....	82
Scan issues .....	83
Network and connection issues .....	84
Printer hardware issues .....	86
HP support .....	88
<b>Appendix A Technical information</b> .....	<b>90</b>
Hewlett-Packard Company notices .....	91
Specifications .....	92
Environmental product stewardship program .....	94
Regulatory information .....	98
<b>Appendix B Errors (Windows)</b> .....	<b>105</b>
Low on ink .....	106
Very low on ink .....	107
Ink cartridge problem .....	108

Check cartridge access door .....	109
Ink cartridge problem .....	110
Paper size mismatch .....	111
Ink cartridge carriage stalled .....	112
Paper jam or tray problem .....	113
Out of paper .....	114
Document failed to print .....	115
Printer failure .....	116
Door open .....	117
Ink cartridge failure .....	118
Counterfeit Cartridge Advisory .....	119
Incompatible ink cartridges .....	120
Paper too short .....	121
Paper too long to auto-duplex .....	122
Incompatible HP Instant Ink Cartridge .....	123
Used HP Instant Ink Cartridge .....	124
Please Connect Printer to HP Connected .....	125
Cannot Print .....	126
HP Protected Cartridge Installed .....	127

<b>Index .....</b>	<b>128</b>
--------------------	------------



---

# 1 How do I?

Learn how to use your HP ENVY 5660 series

- [Get started on page 2](#)
- [Print on page 20](#)
- [Use Web Services on page 29](#)
- [Copy and scan on page 39](#)
- [Work with cartridges on page 47](#)
- [Connect Your Printer on page 56](#)
- [Technical information on page 90](#)
- [Solve a problem on page 66](#)

---

## 2 Get started

This section contains the following topics:

- [Printer parts](#)
- [Control panel and status lights](#)
- [Paper basics](#)
- [Load media](#)
- [Load original](#)
- [Open the HP printer software \(Windows\)](#)
- [Sleep mode](#)
- [Auto-Off](#)
- [Accessibility](#)



# Printer parts

## Front view

Figure 2-1 Front and top views of HP ENVY 5660 e-All-in-One series

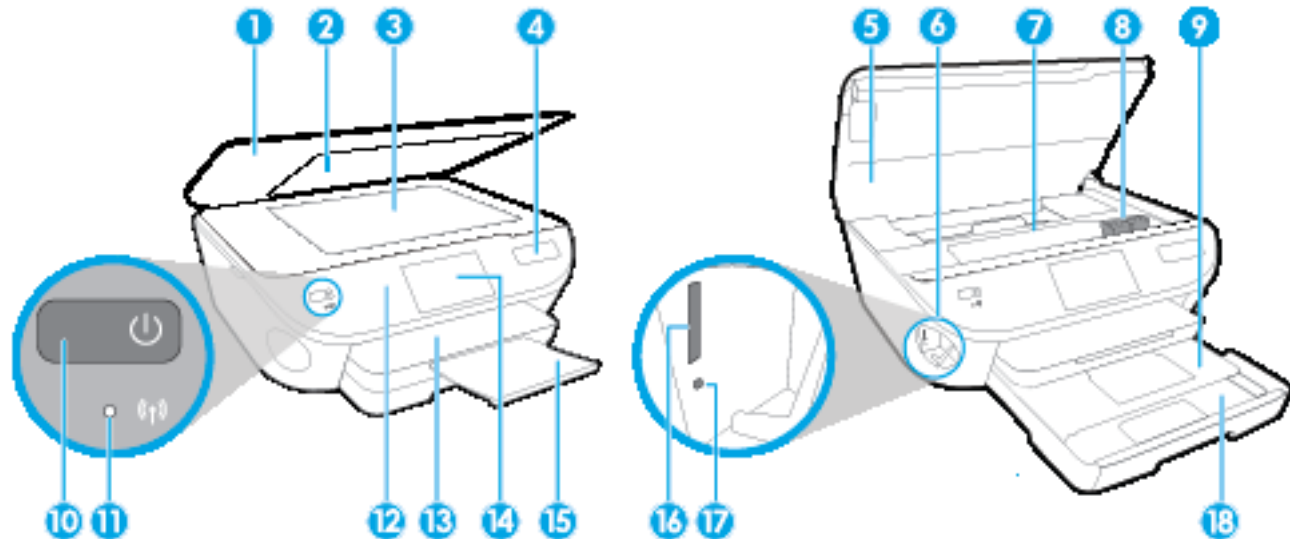

Feature	Description
1	Lid
2	Lid-backing
3	Scanner glass
4	Printer model name
5	Cartridge access door
6	Memory device area
7	Cartridge access area
8	Ink cartridges
9	Photo tray
10	On button (also referred to as the Power button)
11	Wireless status light
12	Control panel
13	Output tray
14	Color graphics display (also referred to as the display)
15	Automatic output tray extender (also referred to as the tray extender)
16	Memory card slot
17	Memory device light
18	Paper tray

## Back view

Figure 2-2 Rear view of HP ENVY 5660 e-All-in-One series

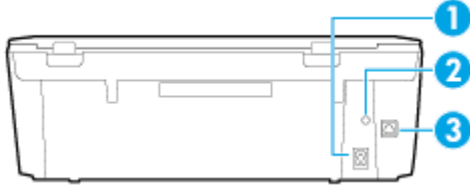

Feature	Description
1	Power connection. Use only the power cord supplied by HP.
2	Power light. The green light indicates the power cord is installed correctly.
3	Rear USB port

# Control panel and status lights

## Overview of buttons and lights

The following diagram and related table provides a quick reference to the printer control panel features.

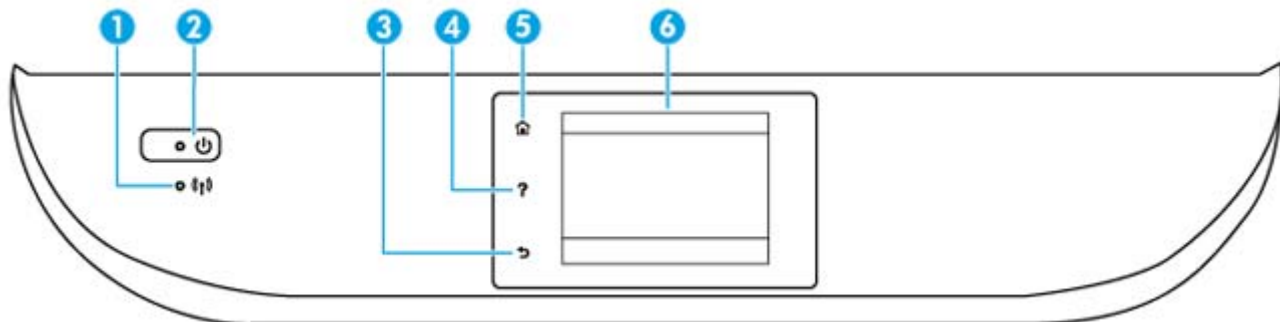

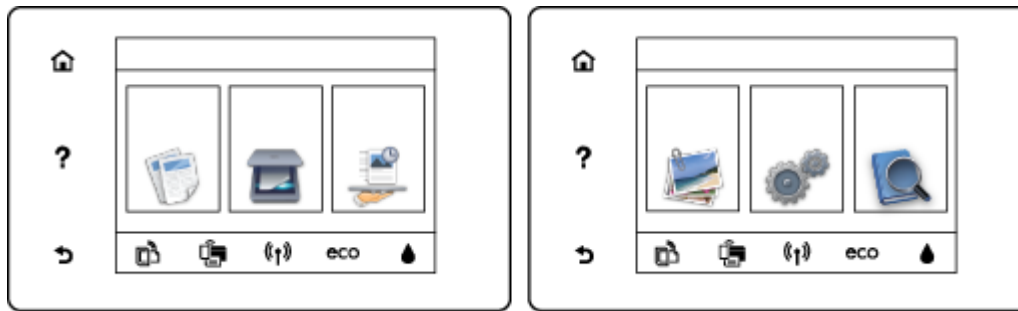

Label	Name and Description
1	Wireless light: Indicates the status of the printer wireless connection. <ul style="list-style-type: none"><li>• Solid blue light indicates that wireless connection has been established and you can print.</li><li>• Slow blinking light indicates that wireless is on, but the printer is not connected to a network. Make sure your printer is within the range of wireless signal.</li><li>• Fast blinking light indicates wireless error. Refer to the message on the printer display.</li><li>• If wireless is turned off, the wireless light is off and the display screen shows <b>Wireless Off</b>.</li></ul>
2	<b>On</b> button: Turns the printer on or off.
3	Back button: Returns to the previous screen.
4	Help button: Opens the Help menu for the current operation.
5	Home button: Returns to the Home screen, the screen that is displayed when you first turn on the printer.
6	Control panel display: Touch the screen to select menu options, or scroll through the menu items.

## Control panel display icons



Icon	Purpose
	<b>Copy:</b> Opens the <b>Copy</b> menu where you can select a copy type or change the copy settings.
	<b>Scan:</b> Opens the <b>Scan</b> menu where you can select a destination for your scan.
	<b>HP Printables:</b> Provides a quick and easy way to access and print information from the web, such as coupons, coloring pages, puzzles, and more.
	<b>Photo:</b> Opens the <b>Photo</b> menu where you can view and print photos, or reprint a printed photo.
	<b>Setup:</b> Opens the <b>Setup</b> menu where you can change preferences and use tools to perform maintenance functions.
	<b>Help:</b> Opens the Help menu where you can view How To videos, printer feature information, and tips.
	ePrint icon: Opens the <b>Web Services Summary</b> menu, where you can check ePrint status details, change ePrint settings, or print an Info page.
	Wi-Fi Direct icon: Opens the <b>Wi-Fi Direct</b> menu where you can turn on Wi-Fi Direct, turn off Wi-Fi Direct, and display the Wi-Fi Direct name and password.
	Wireless icon: Opens the <b>Wireless Summary</b> menu where you can check wireless status and change wireless settings. You can also print a wireless test report, helping diagnose network connection issues.

---

Icon	Purpose
	ECO icon: Displays a screen where you can configure some of the printer environmental features.
	Ink icon: Shows estimated ink levels by cartridge. Displays a warning symbol if the ink level is less than the minimum expected ink level.  <b>NOTE:</b> Ink level warnings and indicators provide estimates for planning purposes only. When you receive a low-ink warning message, consider having a replacement cartridge available to avoid possible printing delays. You do not need to replace cartridges until the print quality becomes unacceptable.

---

# Paper basics

The printer is designed to work well with most types of office paper. It is best to test a variety of print paper types before buying large quantities. Use HP paper for optimum print quality. Visit the HP website at [www.hp.com](http://www.hp.com) for more information about HP paper.



HP recommends plain papers with the ColorLok logo for printing everyday documents. All papers with the ColorLok logo are independently tested to meet high standards of reliability and print quality, and produce documents with crisp, vivid color, bolder blacks, and that dry faster than ordinary plain papers. Look for papers with the ColorLok logo in a variety of weights and sizes from major paper manufacturers.

This section contains the following topics:

- [Recommended papers for printing](#)
- [Order HP paper supplies](#)
- [Tips for selecting and using paper](#)

## Recommended papers for printing

If you want the best print quality, HP recommends using HP papers that are specifically designed for the type of project you are printing.

Depending on your country/region, some of these papers might not be available.

### Photo printing

- **HP Premium Plus Photo Paper**

HP Premium Plus Photo Paper is HP's highest-quality photo paper for your best photos. With HP Premium Plus Photo Paper, you can print beautiful photos that are instant-dry so you can share them right off the printer. It is available in several sizes, including A4, 8.5 x 11 inches, 4 x 6 inches (10 x 15 cm), 5 x 7 inches (13 x 18 cm), and 11 x 17 inches (A3), and in two finishes - glossy or soft gloss (semi-gloss). Ideal for framing, displaying, or gifting your best photos and special photo projects. HP Premium Plus Photo Paper delivers exceptional results with professional quality and durability.

- **HP Advanced Photo Paper**

This thick photo paper features an instant-dry finish for easy handling without smudging. It resists water, smears, fingerprints, and humidity. Your prints have a look and feel comparable to a store-processed photo. It is available in several sizes, including A4, 8.5 x 11 inches, 10 x 15 cm (4 x 6 inches), 13 x 18 cm (5 x 7 inches), and two finishes - glossy or soft-gloss (satin matte). It is acid-free for longer lasting documents.

- **HP Everyday Photo Paper**

Print colorful, everyday snapshots at a low cost, using paper designed for casual photo printing. This affordable photo paper dries quickly for easy handling. Get sharp, crisp images when you

use this paper with any inkjet printer. It is available in glossy finish in several sizes, including A4, 8.5 x 11 inches, and 10 x 15 cm (4 x 6 inches). It is acid-free for longer lasting documents.

- **HP Photo Value Packs**

HP Photo Value Packs conveniently package original HP ink cartridges and HP Advanced Photo Paper to save you time and take the guesswork out of printing affordable, lab-quality photos with your HP printer. Original HP inks and HP Advanced Photo Paper have been designed to work together so your photos are long lasting and vivid, print after print. Great for printing out an entire vacation's worth of photos or multiple prints to share.

## Business documents

- **HP Premium Presentation Paper 120g Matte**

This paper is a heavy two-sided matte paper perfect for presentation, proposals, reports, and newsletters. It is heavyweight for an impressive look and feel.

- **HP Brochure Paper 180g Glossy or HP Professional Paper 180 Glossy**

These papers are glossy-coated on both sides for two-sided use. They are the perfect choice for near-photographic reproductions and business graphics for report covers, special presentations, brochures, mailers, and calendars.

- **HP Brochure Paper 180g Matte or HP Professional Paper 180 Matt**

These papers are matte-coated on both sides for two-sided use. They are the perfect choice for near-photographic reproductions and business graphics for report covers, special presentations, brochures, mailers, and calendars.

## Everyday printing

All the papers listed for everyday printing feature ColorLok Technology for less smearing, bolder blacks, and vivid colors.

- **HP Bright White Inkjet Paper**

HP Bright White Inkjet Paper delivers high-contrast colors and sharp text. It is opaque enough for two-sided color usage with no show-through, which makes it ideal for newsletters, reports, and flyers.

- **HP Printing Paper**

HP Printing Paper is a high-quality multifunction paper. It produces documents that look and feel more substantial than documents printed on standard multipurpose or copy paper. It is acid-free for longer lasting documents.

- **HP Office Paper**

HP Office Paper is a high-quality multifunction paper. It is suitable for copies, drafts, memos, and other everyday documents. It is acid-free for longer lasting documents.

- **HP Office Recycled Paper**

HP Office Recycled Paper is a high-quality multifunction paper made with 30% recycled fiber.

## Order HP paper supplies

The printer is designed to work well with most types of office paper. Use HP paper for optimum print quality.

To order HP papers and other supplies, go to [www.hp.com](http://www.hp.com). At this time, some portions of the HP website are available in English only.

HP recommends plain papers with the ColorLok logo for printing and copying of everyday documents. All papers with the ColorLok logo are independently tested to meet high standards of reliability and print quality, and produce documents with crisp, vivid color, bolder blacks and dry faster than ordinary plain papers. Look for papers with the ColorLok logo in a variety of weights and sizes from major paper manufacturers.

## Tips for selecting and using paper

For the best results, observe the following guidelines.

- Load only one type of paper at a time into the paper or photo tray.
- When loading the tray, make sure the paper is loaded correctly.
- Do not overload the tray.
- To prevent jams, poor print quality, and other printing problems, avoid loading the following paper in the tray:
  - Multipart forms
  - Media that is damaged, curled, or wrinkled
  - Media with cutouts or perforations
  - Media that is heavily textured, embossed, or does not accept ink well
  - Media that is too lightweight or stretches easily
  - Media that contains staples or clips



# Load media

Select a paper size to continue.

## To load small-size paper

1. Pull out the photo tray.

If you do not see the photo tray, remove the output tray from the printer.



2. Load paper.

- Insert a stack of photo paper into the photo tray print side down.



- Slide the photo paper forward until it stops.

3. Push the photo tray back in.
4. Change or retain the paper settings on the printer display.

## To load full-size paper

1. Pull out the paper tray, slide the paper-width guides outward, and then remove any previously loaded media.



2. Load paper.

- Insert a stack of paper into the paper tray with the short edge forward and the print side down.
- Slide the paper forward until it stops.
- Slide the paper-width guides inward until they stop at the edges of the paper.

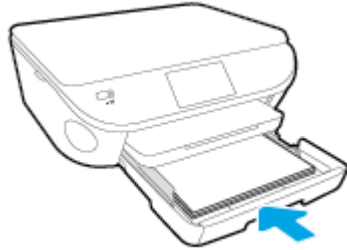

3. Push the paper tray back in.

4. Change or retain the paper settings on the printer display.

**To load legal paper**

1. Pull out the paper tray, slide the paper-width guides outward, and then remove any previously loaded media.



2. Unlock and open the front side of the paper tray.

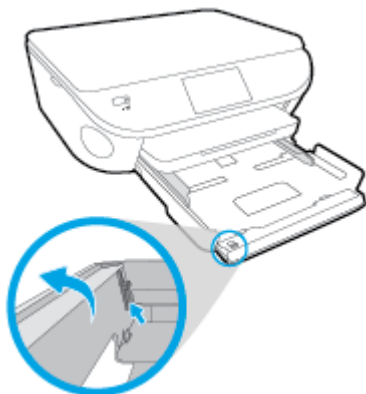

3. Load paper.

- Insert a stack of paper into the paper tray with the short edge forward and the print side down.
- Slide the paper forward until it stops.

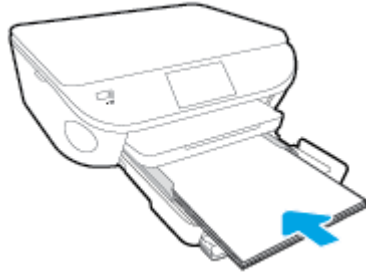

- Slide the paper-width guides inward until they stop at the edges of the paper.

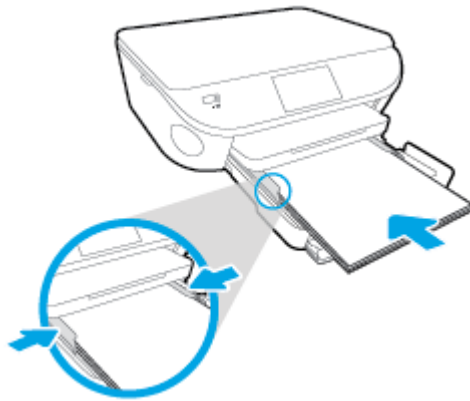

4. Push the paper tray back in.
5. Change or retain the paper settings on the printer display.

### To load envelopes

1. Pull out the paper tray, slide the paper-width guides outward, and then remove any previously loaded media.



2. Load envelopes
  - Insert one or more envelopes in the center of the paper tray. The print side should face down. The flap should be on the left side and facing up.

- Slide a stack of envelopes inward until it stops.

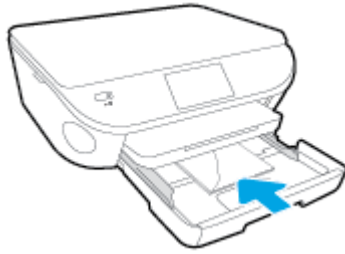

- Slide the paper-width guides inward against the stack of envelopes until they stop.
3. Push the paper tray back in.
  4. Change or retain the paper settings on the printer display.

# Load original

To load original on the scanner glass

1. Lift the scanner lid.



2. Load the original print side down on the right front corner of the glass.

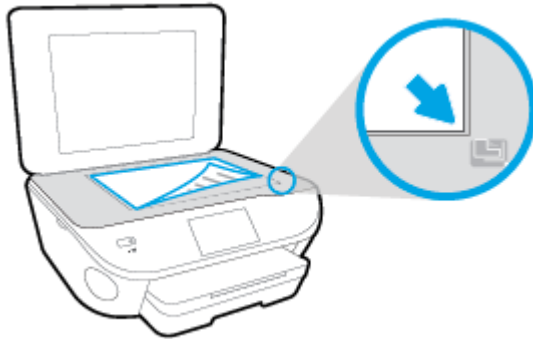

3. Close the scanner lid.

## Open the HP printer software (Windows)

After installing the HP printer software, depending on your operating system, do one of the following:

- **Windows 8.1:** Click the down arrow in lower left corner of the Start screen, and then select the printer name.
- **Windows 8:** Right-click an empty area on the Start screen, click **All Apps** on the app bar, and then select the printer name.
- **Windows 7, Windows Vista, and Windows XP:** From the computer desktop, click **Start**, select **All Programs**, click **HP**, click the folder for the printer, and then select the icon with the printer's name.

# Sleep mode

- Power usage is reduced while in the Sleep mode.
- After initial setup of printer, the printer will enter the Sleep mode after five minutes of inactivity.
- The time to the Sleep mode can be changed from the control panel.

## To set the Sleep mode time

1. From the Home screen, touch  (Setup).
2. Touch **Preferences**.
3. Scroll through the options, and then touch **Sleep Mode**.
4. Touch **After 5 minutes** or **After 10 minutes**, or **After 15 minutes**.

# Auto-Off

Auto-Off is automatically enabled by default when you turn on the printer. When Auto-Off is enabled, the printer will automatically turn off after 2 hours of inactivity to help reduce energy use. **Auto-Off turns the printer off completely, so you must use the On button to turn the printer back on.** Even when Auto-Off is disabled, the printer enters Sleep mode after 5 minutes of inactivity to help reduce energy use.

You can change the Auto-Off setting from the control panel.

## To change Auto-Off setting

1. From the Home screen on the printer display, select **Preferences**.



---

**NOTE:** If you do not see the Home screen, press the **Home** button.

---

2. From the **Preferences** menu, select **Auto-Off**.
3. From the **Auto-Off** menu, select **On** or **Off**, and then press **OK** to confirm the setting.

Once you change the setting, the printer maintains the setting.



# Accessibility

The printer provides a number of features that make it accessible for people with disabilities.

## Visual

The HP software provided with the printer is accessible for users with visual impairments or low vision by using your operating system's accessibility options and features. The software also supports most assistive technology such as screen readers, Braille readers, and voice-to-text applications. For users who are color blind, colored buttons and tabs used in the HP software have simple text or icon labels that convey the appropriate action.

## Mobility

For users with mobility impairments, the HP software functions can be executed through keyboard commands. The HP software also supports Windows accessibility options such as StickyKeys, ToggleKeys, FilterKeys, and MouseKeys. The printer doors, buttons, paper trays, and paper-width guides can be operated by users with limited strength and reach.

## Support

For more details about the accessibility of this printer and HP's commitment to product accessibility, visit HP's website at [www.hp.com/accessibility](http://www.hp.com/accessibility).

For accessibility information for Mac OS X, visit the Apple website at [www.apple.com/accessibility](http://www.apple.com/accessibility).

---

# 3 Print

Most print settings are automatically handled by the software application. Change the settings manually only when you want to change print quality, print on specific types of paper, or use special features.

This section contains the following topics:

- [Print photos](#)
- [Print documents](#)
- [Print on both sides \(duplexing\)](#)
- [Print with AirPrint](#)
- [Print using the maximum dpi](#)
- [Tips for print success](#)

# Print photos

Make sure photo paper is loaded into the photo tray.

## To print photos from a memory device

1. Insert a memory device into the slot.

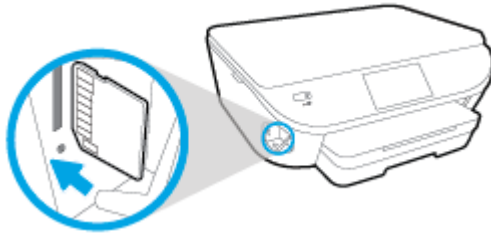

2. On the printer display, select a photo that you want to print and touch **Continue**.
3. Specify the number of photos to print.
4. Touch  (**Edit**) to change brightness, crop, or rotate the selected photo, or touch  (**Print Settings**) to use such features as **Red Eye Removal** or **Photo Fix**.
5. Touch **Continue** and preview the selected photo.
6. Touch **Print** to begin printing.

## To print a photo from the printer software

1. From your software, select **Print**.
2. Make sure your printer is selected.
3. Click the button that opens the **Properties** dialog box.

Depending on your software application, this button might be called **Properties**, **Options**, **Printer Setup**, **Printer Properties**, **Printer**, or **Preferences**.

4. Select the appropriate options.
  - On the **Layout** tab, select **Portrait** or **Landscape** orientation.
  - On the **Paper/Quality** tab, select the appropriate paper type from the **Media** drop-down list in the **Tray Selection** area, and then select the appropriate print quality in the **Quality Settings** area.
  - Click **Advanced** to select the appropriate paper size from the **Paper Size** drop-down list.
5. Click **OK** to return to the **Properties** dialog box.
6. Click **OK**, and then click **Print** or **OK** in the **Print** dialog box.

---

 **NOTE:** After the printing is finished, remove unused photo paper from the photo tray. Store the photo paper so it does not start to curl, which could reduce the quality of your printout.

---

## To print a photo from the computer (OS X)

1. Load paper in the tray. For more information, see [Load media on page 11](#).
2. From the **File** menu in your software, choose **Print**.
3. Make sure your printer is selected.
4. Set the print options.

If you do not see options on the Print dialog, click **Show Details**.

---

 **NOTE:** The following options are available for a USB connected printer. Locations for the options can vary from one application to another.

---

- a. Choose the appropriate paper size in the **Paper Size** pop-up menu.

---

 **NOTE:** If you change the **Paper Size** ensure that you have loaded the correct paper and set the paper size on the printer control panel to match.

---

- b. Select an **Orientation**.
- c. From the pop-up menu, choose **Paper Type/Quality**, and then choose the following settings:
  - **Paper Type:** The appropriate photo paper type
  - **Quality:** **Best** or **Maximum dpi**
  - Click the **Color Options** disclosure triangle, and then choose the appropriate **Photo Fix** option.
    - **Off:** applies no changes to the image.
    - **Basic:** automatically focuses the image; moderately adjusts image sharpness.
5. Select any other print settings you want, and then click **Print**.

# Print documents

Make sure paper is loaded into the paper tray.

## To print a document

1. From your software, select **Print**.
2. Make sure your printer is selected.
3. Click the button that opens the **Properties** dialog box.

Depending on your software application, this button might be called **Properties**, **Options**, **Printer Setup**, **Printer Properties**, **Printer**, or **Preferences**.

4. Select the appropriate options.
  - On the **Layout** tab, select **Portrait** or **Landscape** orientation.
  - On the **Paper/Quality** tab, select the appropriate paper type from the **Media** drop-down list in the **Tray Selection** area, and then select the appropriate print quality in the **Quality Settings** area.
  - Click **Advanced** to select the appropriate paper size from the **Paper Size** drop-down list.
5. Click **OK** to close the **Properties** dialog box.
6. Click **Print** or **OK** to begin printing.

## To print documents (OS X)

1. Load paper in the tray. For more information, see [Load media on page 11](#).
2. From the **File** menu in your software, choose **Print**.
3. Make sure your printer is selected.
4. Specify the page properties.

If you do not see options on the Print dialog, click **Show Details**.

---

 **NOTE:** The following options are available for a USB connected printer. Locations for the options can vary from one application to another.

---

- Choose the paper size.

---

 **NOTE:** If you change the **Paper Size** ensure that you have loaded the correct paper and set the paper size on the printer control panel to match.

---

- Select the orientation.
- Enter the scaling percentage.

5. Click **Print**.

---

 **NOTE:** If your printed documents are not aligned within the margins of the paper, make sure that you have selected the correct language and region. On the printer display, select **Settings**, and then select **Preferences**. Select your language, and then region from the options provided. The correct language and country/region settings ensure that the printer will have the appropriate default paper size settings.

---

# Print on both sides (duplexing)

## To print on both sides of the page

You can print on both sides of a sheet of paper automatically by using the automatic two-sided printing mechanism (duplexer).

1. From your software, select **Print**.
2. Make sure your printer is selected.
3. Click the button that opens the **Properties** dialog box.

Depending on your software application, this button might be called **Properties**, **Options**, **Printer Setup**, **Printer Properties**, **Printer**, or **Preferences**.

4. Select the appropriate options.
  - On the **Layout** tab, select **Portrait** or **Landscape** orientation, and select **Flip on Long Edge** or **Flip on Short Edge** from the **Print on Both Sides** drop-down list.
  - On the **Paper/Quality** tab, select the appropriate paper type from the **Media** drop-down list in the **Tray Selection** area, and then select the appropriate print quality in the **Quality Settings** area.
  - Click the **Advanced** button, in the **Paper/Output** area, select the appropriate paper size from the **Paper Size** drop-down list.



---

**NOTE:** If you change the **Paper Size** ensure that you have loaded the correct paper and set the paper size on the printer control panel to match.

---

5. Click **OK** to print.



---

**NOTE:** After one page of the document has been printed, wait for the printer to reload the paper automatically to print on the other side. You do not need to take any action.

---

## To print on both sides of the page (OS X)

1. From the **File** menu in your software, choose **Print**.
2. In the Print dialog, choose **Layout** from the pop-up menu.
3. Choose the type of binding you want for your two-sided pages, and then click **Print**.

## Print with AirPrint

Printing using Apple's AirPrint is supported for iOS 4.2 and Mac OS X 10.7 or later. Use AirPrint to print wirelessly to the printer from an iPad (iOS 4.2), iPhone (3GS or later), or iPod touch (third generation or later) in the following mobile applications:

- Mail
- Photos
- Safari
- Supported third-party applications, for example Evernote

To use AirPrint, ensure the following:

- The printer and the Apple device must be connected to the same network as your AirPrint enabled device. For more information about using AirPrint and about which HP products are compatible with AirPrint, go to [www.hp.com/go/mobileprinting](http://www.hp.com/go/mobileprinting).
- Load paper that matches the paper settings of the printer.

# Print using the maximum dpi

Use maximum dots per inch (dpi) mode to print high-quality, sharp images on photo paper.

Printing in maximum dpi takes longer than printing with other settings and requires a large amount of disk space.

## To print in maximum dpi mode

1. From your software, select **Print**.
2. Make sure your printer is selected.
3. Click the button that opens the **Properties** dialog box.  
Depending on your software application, this button might be called **Properties**, **Options**, **Printer Setup**, **Printer Properties**, **Printer**, or **Preferences**.
4. Click the **Paper/Quality** tab.
5. From the **Media** drop-down list, select the appropriate paper type and print quality.
6. Click the **Advanced** button.
7. In the **Printer Features** area, select **Yes** from the **Print in Max DPI** drop-down list.
8. Select the appropriate paper size from the **Paper Size** drop-down list.
9. Click **OK** to close the advanced options.
10. Confirm **Orientation** on the **Layout** tab, and then click **OK** to print.

## To print using maximum dpi (OS X)

1. From the **File** menu in your software, choose **Print**.
2. Make sure your printer is selected.
3. Set the print options.

If you do not see options on the Print dialog, click **Show Details**.

---

 **NOTE:** The following options are available for a USB connected printer. Locations for the options can vary from one application to another.

---

- a. Choose the appropriate paper size in the **Paper Size** pop-up menu.

---

 **NOTE:** If you change the **Paper Size** ensure that you have loaded the correct paper and set the paper size on the printer control panel to match.

---

- b. From the pop-up menu, choose **Paper Type/Quality**, and then choose the following settings:
  - **Paper Type:** The appropriate paper type
  - **Quality:** **Maximum dpi**
4. Select any other print settings that you want, and then click **Print**.



# Tips for print success

Use the following tips to print successfully.

## Tips for printing from a computer

For more information on printing documents, photos, or envelopes from a computer, use the following links to operating-system specific instructions.

- Learn how to print photos saved on your computer. [Click here to go online for more information.](#)
- Learn how to print envelopes from your computer. [Click here to go online for more information.](#)

## Tips for ink and paper

- Use original HP cartridges. Original HP cartridges are designed for and tested with HP printers to help you produce great results, time after time.
- Make sure the cartridges have sufficient ink. To view the estimated ink levels, touch  (Ink) from the Home screen.

To learn more tips about working with cartridges, see [Tips for working with cartridges on page 55](#) for more information.

- Load a stack of paper, not just one page. Use clean and flat paper of the same size. Make sure only one type of paper is loaded at a time.
- Adjust the paper-width guides in the paper tray to fit snugly against all paper. Make sure the paper-width guides do not bend the paper in the paper tray.
- Set the print quality and paper size settings according to the type and size of paper loaded in the paper tray.

## Printer settings tips

- On the **Paper/Quality** tab, select the appropriate paper type from the **Media** drop-down list in the **Tray Selection** area, and then select the appropriate print quality in the **Quality Settings** area.
- Select the appropriate paper size from the **Paper Size** drop-down list in the **Advanced Options** dialog box. Access the **Advanced Options** dialog box by clicking the **Advanced** button on the **Layout** or **Paper/Quality** tab.
- To change default print settings, click **Print & Scan**, and then click **Set Preferences** in the printer software.

Depending on your operating system, do one of the following to open the printer software:

- **Windows 8.1:** Click the down arrow in lower left corner of the Start screen, and then select the printer name.
- **Windows 8:** On the **Start** screen, right-click an empty area on the screen, click **All Apps** on the app bar, and then click the icon with the printer's name.
- **Windows 7, Windows Vista, and Windows XP:** From the computer desktop, click **Start**, select **All Programs**, click **HP**, click **HP ENVY 5660 series**, and then click **HP ENVY 5660 series**.
- If you want to print a black and white document using black ink only, click the **Advanced** button. From the **Print in Grayscale** drop-down menu, select **Black Ink Only**, then click the **OK** button.

### Printer settings tips

- On the Print dialog, use the **Paper Size** pop-up menu to select the size of paper loaded in the printer.
- On the Print dialog, choose the **Paper Type/Quality** pop-up menu and select the appropriate paper type and quality.
- To print a black and white document using only black ink, choose the **Paper Type/Quality** from the pop-up menu and choose **Grayscale** from the Color pop-up menu.

### Notes

- Original HP ink cartridges are designed and tested with HP printers and papers to help you easily produce great results, time after time.



---

**NOTE:** HP cannot guarantee the quality or reliability of non-HP supplies. Product service or repairs required as a result of using a non-HP supply will not be covered under warranty.

If you believe you purchased original HP ink cartridges, go to:

[www.hp.com/go/anticounterfeit](http://www.hp.com/go/anticounterfeit)

---

- Ink level warnings and indicators provide estimates for planning purposes only.



---

**NOTE:** When you receive a low-ink warning message, consider having a replacement cartridge available to avoid possible printing delays. You do not need to replace the cartridges until print quality becomes unacceptable.

---

- Software settings selected in the print driver only apply to printing, they do not apply to copying or scanning.
- You can print your document on both sides of the paper.

---

# 4 Use Web Services

- [What are Web Services?](#)
- [Set up Web Services](#)
- [Print with HP ePrint](#)
- [Use HP Printables](#)
- [Use the HP Connected website](#)
- [Remove Web Services](#)
- [Tips for using Web Services](#)

# What are Web Services?

## ePrint

- **ePrint** is a free service from HP that allows you to print to your HP ePrint-enabled printer anytime, from any location. It's as simple as sending an email to the email address assigned to your printer when you enable Web Services on the printer. No special drivers or software are needed. If you can send an email, you can print from anywhere, using **ePrint**.

Once you have signed up for an account on HP Connected ([www.hpconnected.com](http://www.hpconnected.com)), you can sign in to view your **ePrint** job status, manage your **ePrint** printer queue, control who can use your printer's **ePrint** email address to print, and get help for **ePrint**.

## HP Printables

- HP Printables allow you to easily locate and print preformatted web content, directly from your printer. You can also scan and store your documents digitally on the Web.

HP Printables provide a wide range of content, from store coupons to family activities, news, travel, sports, cooking, photos, and many more. You can even view and print your online images from popular photo sites.

Certain HP Printables also allow you to schedule the delivery of app content to your printer.

Preformatted content designed specifically for your printer means no cut-off text and pictures and no extra pages with only one line of text. On some printers, you can also choose paper and print quality settings on the print preview screen.

# Set up Web Services

Before you set up Web Services, make sure your printer is connected to the Internet using wireless connection.

To set up Web Services, use one of the following methods.

## To set up Web Services using the printer control panel

1. From the printer control panel display, touch **Setup**.
2. Touch **Web Services Setup**.
3. Touch **Accept** to accept the Web Services terms of use and enable Web Services.
4. In the **Auto Update** screen, touch **Yes** to allow the printer to automatically check for and install product updates.

---

 **NOTE:** If a printer update is available, the printer will download and install the update, and then restart. You will have to repeat the instructions from step 1 to set up **ePrint**.

 **NOTE:** If prompted for proxy settings and if your network uses proxy settings, follow the on-screen instructions to set up a proxy server. If you do not have the proxy details, contact your network administrator or the person who set up the network.

---

5. When the printer is connected to the server, the printer prints an information page. Follow the instructions on the information page to finish the setup.

## To set up Web Services using the embedded web server

1. Open the EWS. For more information, see [Open the embedded Web server on page 64](#).
2. Click the **Web Services** tab.
3. In the **Web Services Settings** section, click **Setup**, click **Continue**, and follow the on-screen instructions to accept the terms of use.
4. If prompted, choose to allow the printer to check for and install printer updates.

---

 **NOTE:** If a printer update is available, the printer downloads and installs the update, and then restarts. Repeat the instructions from step 1 to set up **ePrint**.

 **NOTE:** If prompted for proxy settings and if your network uses proxy settings, follow the on-screen instructions to set up a proxy server. If you do not have the proxy details, contact your network administrator or the person who set up the network.

---

5. When the printer is connected to the server, the printer prints an information page. Follow the instructions on the information page to finish the setup.

## To set up Web Services using the HP printer software (Windows)

1. Open the HP printer software. For more information, see [Open the HP printer software \(Windows\) on page 16](#).
2. In the window that appears, double-click **Print & Scan** and then select **Connect Printer to the Web** under Print. The printer's home page (embedded web server) opens.
3. Click the **Web Services** tab.

4. In the **Web Services Settings** section, click **Setup**, click **Continue**, and follow the on-screen instructions to accept the terms of use.
5. If prompted, choose to allow the printer to check for and install printer updates.

---

 **NOTE:** If a printer update is available, the printer will download and install the update, and then restart. You will have to repeat the instructions from step 1 to set up **ePrint**.

 **NOTE:** If prompted for proxy settings and if your network uses proxy settings, follow the on-screen instructions to set up a proxy server. If you do not have the details, contact your network administrator or the person who set up the network.

---

6. When the printer is connected to the server, the printer prints an information page. Follow the instructions on the information page to finish the setup.

# Print with HP ePrint

HP ePrint is a free service from HP that allows you to print to your HP ePrint-enabled printer anywhere you can send an email. Just send your documents and photos to the email address assigned to your printer when you enable Web Services. No additional drivers or software are needed.

- Your printer needs to have a wireless network connection to the Internet. You will not be able to use HP ePrint via a USB connection to a computer.
- Attachments might print differently from the way they appear in the software program that created them, depending on the original fonts and layout options used.
- Free product updates are provided with HP ePrint. Some updates might be required to enable certain functionality.

Once you have signed up for an account on HP Connected ([www.hpconnected.com](http://www.hpconnected.com)), you can sign in to view your ePrint job status, manage your ePrint printer queue, control who can use your printer's ePrint email address to print, and get help for ePrint.

Before you can use ePrint, make sure that:

- The printer is connected to an active network providing Internet access.
- Web Services is turned on. If not, you will be prompted to turn it on.

## To ePrint a document from anywhere

1. Enable Web Services.
  - a. From the Home screen, touch the  (ePrint) icon.
  - b. Accept the Terms of Use, and then follow the onscreen instructions to enable Web Services.
  - c. Print the ePrint information page, and then follow the instructions on the page to sign up for an ePrint account.
2. Find your ePrint email address.
  - a. Touch the **ePrint** icon on the Home screen. You will see the **Web Services Settings** menu on the printer display.
  - b. The printer's email address appears in the **Web Services Settings** menu.
3. Email your document to the printer for printing.
  - a. Create a new email and attach the document to print.
  - b. Send the email to the printer email address.

The printer prints the attached document.

---

 **NOTE:** The **ePrint** server does not accept email print jobs if there are multiple email addresses included in the "To" or "Cc" fields. Only enter the HP ePrint email address in the "To" field. Do not enter any additional email addresses in the other fields.

---

---

 **NOTE:** The email will be printed once it is received. As with any email, there is no guarantee when or whether it will be received. You can check the print status on HP Connected ([www.hpconnected.com](http://www.hpconnected.com)).

 **NOTE:** Documents printed with **ePrint** may appear different from the original. Style, formatting, and text flow may differ from the original document. For documents that need to be printed with a higher quality (such as legal documents), we recommend that you print from the software application on your computer, where you will have more control over what your printout looks like.

---

 [Click here to go online for more information.](#)



## Use HP Printables

Print pages from the web, without using a computer, by setting up HP Printables, a free service from HP. You can print coloring pages, calendars, puzzles, recipes, maps, and more, depending on the apps available in your country/region.

Go to the HP Connected website for more information and specific terms and conditions:

[www.hpconnected.com](http://www.hpconnected.com).



## Use the HP Connected website

Use HP's free HP Connected website to set up increased security for HP ePrint, and specify the email addresses that are allowed to send email to your printer. You can also get product updates, more apps, and other free services.

Go to the HP Connected website for more information and specific terms and conditions:  
[www.hpconnected.com](http://www.hpconnected.com).

# Remove Web Services

## To remove Web Services

1. From the printer control panel display, touch  (ePrint), and then touch  (Web Services Settings).
2. Touch **Remove Web Services**.

# Tips for using Web Services

Use the following tips to print apps and use HP ePrint.

## Tips for printing apps and using HP ePrint

- Learn how to share your photos online and order prints. [Click here to go online for more information.](#)
- Learn about apps for printing recipes, coupons, and other content from the web, simply and easily. [Click here to go online for more information.](#)

---



# 5 Copy and scan

- [Copy documents](#)
- [Scan](#)
- [Tips for copy and scan success](#)

# Copy documents

The **Copy** menu on the printer display allows you to easily select number of copies and color or black and white for copying on plain paper. You can also easily access advanced settings, such as changing the paper type and size, adjusting the darkness of the copy, and resizing the copy.

## Make a 1-sided copy

1. Load the original print side down on the right front corner of the scanner glass.
2. Specify number of copies and settings.
  - From the Home screen, touch **Copy**. Flick to the desired number of copies.
  - If the value for the **2-Sided** option is **1:2**, touch to select **1:1**.
  - Touch  (**Settings**) to specify paper size, paper type, quality, or other settings.
  - Touch  (**Back**) to return to the Copy screen.
3. Touch **Black** or **Color** to start the copy job.

## Make a 2-sided copy

1. Load the original print side down on the right front corner of the scanner glass.
2. Specify number of copies and settings.
  - From the Home screen, touch **Copy**. Flick to the desired number of copies.
  - If the value for the **2-Sided** option is **1:1**, touch to select **1:2**.
  - Touch  (**Settings**), scroll through the options, and then touch **Resize** to make sure **Actual** is selected.



---

**NOTE:** The 2-sided function does not work if the **Fit to Page** option is selected.

---

- From the **Settings** screen, specify paper size, paper type, quality, or other settings.
  - Touch  (**Back**) to return to the Copy screen.
3. Touch **Black** or **Color** to start the copy job.
  4. When prompted, load the second original and touch **OK**.

# Scan

You can scan documents, photos, and other paper types, and send them to a variety of destinations, such as a computer or an email recipient.

When scanning documents with the HP printer software, you can scan to a format that can be searched and edited.



**NOTE:** Some scan functions are only available after you have installed the HP printer software.

- [Scan to a computer](#)
- [Scan to a memory device](#)
- [Scan to Email](#)
- [Scan using Webscan](#)

## Scan to a computer

Before scanning to a computer, make sure you have already installed the HP recommended printer software. The printer and computer must be connected and turned on.

In addition, on Windows computers, the printer software must be running prior to scanning.

### To enable the scan to a computer feature (Windows)

The scan to a computer feature is enabled by default from the factory. Follow these instructions if the feature has been disabled, and you wish to enable it again.

1. Open the HP printer software.
2. Go to the **Scan** section.
3. Select **Manage Scan to Computer**.
4. Click **Enable**.

### To enable the scan to a computer feature (OS X)

The scan to a computer feature is enabled by default from the factory. Follow these instructions if the feature has been disabled, and you wish to enable it again.

1. Open HP Utility.
2. Under **Scan Settings**, click **Scan to Computer**.
3. Ensure that **Enable Scan to Computer** is selected.

### To scan an original from the printer control panel

1. Load the original print side down on the right front corner of the scanner glass.
2. Touch **Scan**, and then select **Computer**.
3. Touch a computer that you want to scan to.

4. Choose the type of scan shortcut you want.
5. Touch **Start Scan**.

#### To scan an original from HP printer software (Windows)

1. Load the original print side down on the right front corner of the scanner glass.
2. Click the **Print & Scan** tab.
3. In the **Scan** area, click **Scan a Document or Photo**.
4. Select the type of scan that you want from the shortcut menu and then click **Scan**.



**NOTE:** If **Show Scan Preview** is selected, you can make adjustments to the scanned image in the preview screen.

5. Select **Save** if you want to keep the application open for another scan, or select **Done** to exit the application.
6. Click **Scan**.

After the scan is saved, Windows Explorer opens the directory with the saved scan.

#### To scan an original from HP printer software (OS X)

1. Open HP Scan.  
HP Scan is located in the **Applications/Hewlett-Packard** folder at the top level of the hard disk.
2. Choose the type of scan profile you want and follow the on-screen instructions.

## Scan to a memory device

You can scan directly to a memory card or USB flash drive from the printer control panel without using a computer or the HP printer software provided with the printer.

#### To scan an original to a memory device from the printer control panel

1. Load the original print side down on the right front corner of the scanner glass.
2. Insert a memory device.

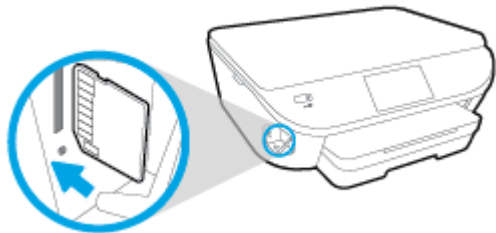

3. Touch **Scan**, and then select **Memory Device**.
4. Make changes to scan options, if needed.
5. Touch **Start Scan**.



## Scan to Email

The Scan-to-Email App is an application that allows you to quickly scan and email photos or documents to the specified recipients directly from your HP e-All-in-One printer. You can set up your email addresses, log in to your accounts with the given PIN codes, and then scan and email your documents.

This section contains the following topics:

- [Set up Scan to Email](#)
- [Use Scan to Email](#)
- [Change account settings](#)

### Set up Scan to Email

#### To set up Scan to Email

1. Touch **Scan**, and then touch **Email**.
2. On the **Welcome** screen, touch **Continue**.
3. Touch in the **Email:** box to enter your email address, and then touch **Done**.
4. Touch **Continue**.
5. A PIN will be sent to the email address you entered. Touch **Continue**.
6. Touch the **PIN** to enter your PIN and then touch **Done**.
7. Touch **Store Email** or **Auto-login**, depending upon how you want the printer to store your login information.
8. Select your scan type by touching **Photo** or **Document**.
9. For photos, select the can settings, and touch **Continue**.  
For documents, continue with the next step.
10. Verify the email information, and touch **Continue**.
11. Touch **Scan to Email**.
12. Touch **OK** when the scan completes, and then touch **Yes** to send another email, or **No** to finish.

### Use Scan to Email

#### To use Scan to Email

1. Load the original print side down on the right front corner of the scanner glass.
2. Touch **Scan**, and then touch **Email**.
3. On the control panel display, select the account that you want to use, and touch **Continue**.

---

 **NOTE:** Select **My account is not listed** if you do not have an account. You will be prompted to enter your email address and receive a PIN.

---

4. If prompted, enter the PIN.

5. Select your scan type by touching **Photo** or **Document**.
6. For photos, select the scan settings, and touch **Continue**.  
For documents, continue with the next step.
7. To add or remove recipients, touch **Modify Recipient(s)**, and when finished touch **Done**.
8. Verify the email information and touch **Continue**.
9. Touch **Scan to Email**.
10. Touch **OK** when the scan completes, and then touch **Yes** to send another email, or **No** to finish.

## Change account settings

### To change account settings

1. Touch **Scan**, and then touch **Email**.
2. On the control panel display, select the account that you want to change, and touch **Modify**.
3. Select which setting you want to modify, and follow the onscreen prompts.
  - Auto-login
  - Store Email
  - Remove from list
  - Change PIN
  - Delete Account

## Scan using Webscan

Webscan is a feature of the embedded web server that lets you scan photos and documents from your printer to your computer using a web browser.

This feature is available even if you did not install the printer software on your computer.



---

**NOTE:** By default, Webscan is off. You can enable this feature from the EWS.

If you are unable to open Webscan in the EWS, your network administrator might have turned it off. For more information, contact your network administrator or the person who set up your network.

---

### To enable Webscan

1. Open the embedded web server. For more information, see [Open the embedded Web server on page 64](#).
2. Click the **Settings** tab.
3. In the **Security** section, click **Administrator Settings**.
4. Select **Webscan** to enable Webscan.
5. Click **Apply** and then click **OK**.

## To scan using Webscan

Scanning using Webscan offers basic scan options. For additional scan options or functionality, scan from the HP printer software.

1. Load the original print side down on the right front corner of the scanner glass.
2. Open the embedded web server. For more information, see [Open the embedded Web server on page 64](#).
3. Click the **Scan** tab.
4. Click **Webscan** in the left pane, change any settings, and then click **Start Scan**.

## Tips for copy and scan success

Use the following tips to copy and scan successfully:

- Learn how to scan to email from the printer display. [Click here to go online for more information.](#)
- Keep the glass and the back of the lid clean. The scanner interprets anything it detects on the glass as part of the image.
- Load your original, print side down, on the right front corner of the glass.
- To make a large copy of a small original, scan the original into the computer, resize the image in the scanning software, and then print a copy of the enlarged image.
- If you want to adjust scan size, output type, scan resolution, or file type, and so on, start scan from the printer software.
- To avoid incorrect or missing scanned text, make sure the brightness is set appropriately in the software.
- If you want to scan a document with several pages into one file instead of multiple files, start the scan with the printer software instead of selecting **Scan** from the printer display.

---

## 6 Work with cartridges

- [Check the estimated ink levels](#)
- [Replace the cartridges](#)
- [Order ink supplies](#)
- [Use single-cartridge mode](#)
- [Cartridge warranty information](#)
- [Anonymous usage information storage](#)
- [Tips for working with cartridges](#)

# Check the estimated ink levels

## To check the estimated ink levels from the printer control panel

- ▲ From the Home screen, touch the  (Ink icon) to display the estimated ink levels.

## To check the ink levels from the printer software (Windows)

1. Open the HP printer software.
2. In the printer software, click **Estimated Ink Levels**.

## To check the ink levels from HP Utility

1. Open HP Utility.

HP Utility is located in the **Hewlett-Packard** folder in the **Applications** folder at the top level of the hard disk.

2. Select the HP ENVY 5660 series from the list of devices at the left of the window.

3. Click **Supplies Status**.

The estimated ink levels appear.

4. Click **All Settings** to return to the **Information and Support** pane.

---

 **NOTE:** If you have installed a refilled or remanufactured cartridge, or a cartridge that has been used in another printer, the ink level indicator might be inaccurate or unavailable.

 **NOTE:** Ink level warnings and indicators provide estimates for planning purposes only. When you receive a low-ink warning message, consider having a replacement cartridge available to avoid possible printing delays. You do not have to replace the cartridges until the print quality is unacceptable.

 **NOTE:** Ink from the cartridges is used in the printing process in a number of different ways, including in the initialization process, which prepares the product and cartridges for printing, and in printhead servicing, which keeps print nozzles clear and ink flowing smoothly. In addition, some residual ink is left in the cartridge after it is used. For more information, see [www.hp.com/go/inkusage](http://www.hp.com/go/inkusage).

---

# Replace the cartridges

## To replace the cartridges

1. Check that power is on.
2. Remove the old cartridge.
  - a. Open the access door.



- b. Remove the cartridge from the slot.
3. Insert a new cartridge.
  - a. Remove the cartridge from packaging.

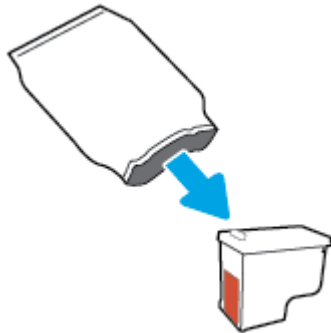

- b. Remove plastic tape using the pull tab.

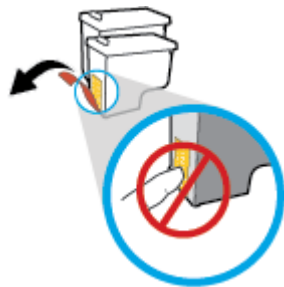

- c. Slide the new cartridge in the slot until it clicks.

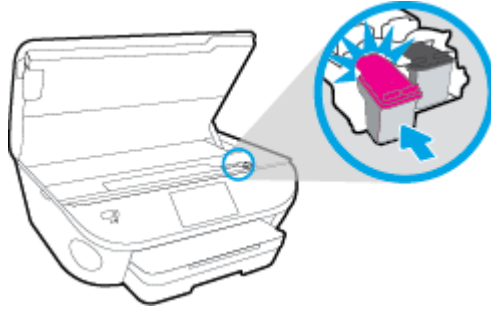

4. Close the cartridge access door.



---

 **NOTE:** The HP printer software prompts you to align the ink cartridges when you print a document after installing a new ink cartridge.

---



# Order ink supplies

Before ordering cartridges, locate the correct cartridge number.

## Locate the cartridge number on the printer

- ▲ The cartridge number is located inside the cartridge access door.



## Locate the cartridge number in the printer software

1. Depending on your operating system, do one of the following to open the printer software:
  - **Windows 8.1:** Click the down arrow in lower left corner of the Start screen, and then select the printer name.
  - **Windows 8:** Right-click an empty area on the Start screen, click **All Apps** on the app bar, and then select the printer name.
  - **Windows 7, Windows Vista, and Windows XP:** From the computer desktop, click **Start**, select **All Programs**, click **HP**, click the folder for the printer, and then select the icon with the printer's name.
2. In the printer software, click **Shop**, and then click **Shop For Supplies Online**.

The correct cartridge number appears when you use this link.

## To find the print cartridge reorder numbers

1. Open HP Utility.

 **NOTE:** HP Utility is located in the **Hewlett-Packard** folder in the **Applications** folder at the top level of the hard disk.

2. Click **Supplies Info**.

The print cartridge ordering numbers appear.

3. Click **All Settings** to return to the **Information and Support** pane.

To order original HP supplies for the HP ENVY 5660 series, go to [www.hp.com/buy/supplies](http://www.hp.com/buy/supplies). If prompted, choose your country/region, and then follow the prompts to find the right cartridges for your printer.

 **NOTE:** Ordering ink cartridges online is not supported in all countries/regions. If it is not available in your country/region, you may still view supplies information and print a list for reference when shopping at a local HP reseller.

## Use single-cartridge mode

Use the single-cartridge mode to operate the HP ENVY 5660 series with only one ink cartridge. The single-cartridge mode is initiated when an ink cartridge is removed from the ink cartridge carriage. During single-cartridge mode, the printer can copy documents, copy photos, and print jobs from the computer.



---

**NOTE:** When the HP ENVY 5660 series operates in single-cartridge mode, a message is displayed on the printer display. If the message is displayed and two ink cartridges are installed in the printer, verify that the protective piece of plastic tape has been removed from each ink cartridge. When plastic tape covers the ink cartridge contacts, the printer cannot detect that the ink cartridge is installed.

---

### Exit single-cartridge mode

- Install two ink cartridges in the HP ENVY 5660 series to exit single-cartridge mode.

## Cartridge warranty information

The HP cartridge warranty is applicable when the cartridge is used in its designated HP printing device. This warranty does not cover HP ink cartridges that have been refilled, remanufactured, refurbished, misused, or tampered with.

During the warranty period the cartridge is covered as long as the HP ink is not depleted and the end of warranty date has not been reached. The end of warranty date, in YYYY/MM format, may be found on the cartridge as indicated:

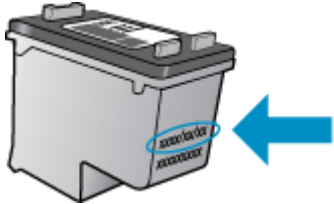

For a copy of the HP Limited Warranty Statement for the printer, see the printed documentation that came with the product.

## Anonymous usage information storage

The HP cartridges used with this printer contain a memory chip that assists in the operation of the printer. In addition, this memory chip stores a limited set of anonymous information about the usage of the printer, which might include the following: the number of pages printed using the cartridge, the page coverage, frequency of printing, and the printing modes used.

This information helps HP design future printers to meet our customers' printing needs. The data collected from the cartridge memory chip does not contain information that can be used to identify a customer or user of the cartridge or their printer.

HP collects a sampling of the memory chips from cartridges returned to HP's free return and recycling program (HP Planet Partners: [www.hp.com/recycle](http://www.hp.com/recycle)). The memory chips from this sampling are read and studied in order to improve future HP printers. HP partners who assist in recycling this cartridge might have access to this data, as well.

Any third party possessing the cartridge might have access to the anonymous information on the memory chip. If you prefer to not allow access to this information, you can render the chip inoperable. However, after you render the memory chip inoperable, the cartridge cannot be used in an HP printer.

If you are concerned about providing this anonymous information, you can make this information inaccessible by turning off the memory chip's ability to collect the printer's usage information.

### To disable the usage information function

1. From the printer control panel, touch **Setup**.
2. Touch **Preferences**.
3. Flick to the end of the option list and switch off the **Automatically Send Anonymous Data** and **Store Anonymous Usage Information** options.



---

**NOTE:** You can continue to use the cartridge in the HP printer if you turn off the memory chip's ability to collect the printer's usage information.

---

## Tips for working with cartridges

Use the following tips to work with cartridges:

- To protect the cartridges from drying out, always turn the printer off using the On button, and wait until the On button light goes out.
- Do not open or untape cartridges until you are ready to install them. Leaving tape on the cartridges reduces ink evaporation.
- Insert the cartridges into the correct slots. Match the color and icon of each cartridge to the color and icon for each slot. Make sure the cartridges snap into place.
- Alignment is automatic after new cartridge installation. Alignment can also help later, in cases of blurred or jagged lines. See [Fix print quality issues on page 77](#) for more information.
- When the Estimated Ink Levels screen shows one or both cartridges in a low state, consider getting replacement cartridges to avoid possible printing delays. You do not need to replace the cartridges until print quality becomes unacceptable. See [Replace the cartridges on page 49](#) for more information.
- If you remove a cartridge from the printer for any reason, try to replace it again as soon as possible. Outside of the printer, if unprotected, cartridges begin to dry out.

---

# 7 Connect Your Printer

Additional advanced settings are available from the printer's home page (embedded web server or EWS). For more information, see [Open the embedded Web server on page 64](#).

This section contains the following topics:

- [Set up the printer for wireless communication](#)
- [Change network settings](#)
- [Advanced printer management tools \(for networked printers\)](#)
- [Tips for setting up and using a networked printer](#)

# Set up the printer for wireless communication

- [Before you begin](#)
- [Set up the printer on your wireless network](#)
- [Change the connection type](#)
- [Test the wireless connection](#)
- [Turn on or off the wireless capability of the printer](#)
- [Connect wirelessly to the printer without a router](#)

## Before you begin

Ensure the following:

- The wireless network is set up and working properly.
- The printer and the computers that use the printer are on the same network (subnet).

While connecting the printer, you might be prompted to enter the wireless network name (SSID) and a wireless password.

- The wireless network name is the name of your wireless network.
- The wireless password prevents other people from connecting to your wireless network without your permission. Depending on the level of security required, your wireless network might use either a WPA passphrase or WEP key.

If you have not changed the network name or the security passkey since setting up your wireless network, you can sometimes find them on the back or side of the wireless router.

If you cannot find the network name or the security password or cannot remember this information, see the documentation provided with your computer or with the wireless router. If you still cannot find this information, contact your network administrator or the person who set up the wireless network.

## Set up the printer on your wireless network

Use the Wireless Setup Wizard from the printer control panel display to set up wireless communication.



**NOTE:** Before you proceed, go through the list at [Before you begin on page 57](#).

1. From the printer control panel, touch (Wireless).
2. Touch (Settings).
3. Touch **Wireless Settings**.
4. Touch **Wireless Setup Wizard**.
5. Follow the display instructions to complete the setup.

## Change the connection type

After you have installed the HP printer software and connected the printer to your computer or to a network, you can use the software to change the connection type (for example, from a USB connection to a wireless connection).



**NOTE:** Connecting an Ethernet cable turns off the wireless capability of the printer.

### To change from a USB connection to a wireless network (Windows)

Before you proceed, go through the list at [Before you begin on page 57](#).

1. Depending on your operating system, do one of the following:
  - **Windows 8.1:** Click the down arrow in lower left corner of the Start screen, select the printer name, and then click **Utilities**.
  - **Windows 8:** Right-click an empty area on the Start screen, click **All Apps** on the app bar, select the printer name, and then click **Utilities**.
  - **Windows 7, Windows Vista, and Windows XP:** From the computer desktop, click **Start**, select **All Programs**, click **HP**, click the folder of your printer.
2. Click **Printer Setup & Software**.
3. Select **Convert a USB connected printer to wireless**. Follow the on-screen instructions.

Learn more about how to change from a USB to wireless connection. [Click here to go online for more information](#). At this time, this website might not be available in all languages.

## Test the wireless connection

Print the wireless test report for information about the printer wireless connection. The wireless test report provides information about the printer status, hardware (MAC) address, and IP address. If the printer is connected to a network, the test report displays details about the network settings.

To print the wireless test report

1. From the printer control panel, touch (Wireless), and then touch (**Settings**).
2. Touch **Print Reports**
3. Touch **Wireless Test Report**.

## Turn on or off the wireless capability of the printer

The blue Wireless light on the printer control panel is lit when the wireless capability of the printer is on.

1. From the printer control panel, touch **Setup** and then touch **Network Setup**.
2. Touch **Wireless Settings**.
3. Touch **Wireless** to turn it on or off.



## Connect wirelessly to the printer without a router

With Wi-Fi Direct, you can print wirelessly from a computer, smart phone, tablet, or other wireless-capable device—without connecting to an existing wireless network.

### Guidelines for using Wi-Fi Direct

- Make sure your computer or mobile device has the necessary software.  
If you are using a computer, make sure you have installed the printer software provided with the printer.
- If you have not installed the HP printer software on the computer, connect to Wi-Fi Direct first and then install the printer software. Select **Wireless** when prompted by the printer software for a connection type.
- If you are using a mobile device, make sure you have installed a compatible printing app. For more information about mobile printing, visit [www.hp.com/global/us/en/eprint/mobile\\_printing\\_apps.html](http://www.hp.com/global/us/en/eprint/mobile_printing_apps.html).
- Make sure Wi-Fi Direct is turned on in the printer and, if necessary, security is enabled.
- Up to five computers and mobile devices can use the same Wi-Fi Direct connection.
- Wi-Fi Direct can be used while the printer is also connected either to a computer using a USB cable or to a network using a wireless connection.
- Wi-Fi Direct cannot be used to connect a computer, mobile device, or printer to the Internet.

### To print from a wireless-capable mobile device

Make sure you have installed a compatible printing app on your mobile device. For more information, visit [www.hp.com/global/us/en/eprint/mobile\\_printing\\_apps.html](http://www.hp.com/global/us/en/eprint/mobile_printing_apps.html).

1. Make sure you have turned on Wi-Fi Direct on the printer.
2. Turn on the Wi-Fi connection on your mobile device. For more information, see the documentation provided with the mobile device.



---

**NOTE:** If your mobile device does not support Wi-Fi, you are not able to use Wi-Fi Direct.

---

3. From the mobile device, connect to a new network. Use the process you normally use to connect to a new wireless network or hotspot. Choose the Wi-Fi Direct name from the list of wireless networks shown such as DIRECT-\*\*- HP ENVY-5660 (where \*\* are the unique characters to identify your printer).

Enter the Wi-Fi Direct password when prompted.

4. Print your document.

### To print from a wireless-capable computer (Windows)

1. Make sure you have turned on Wi-Fi Direct on the printer.
2. Turn on the computer's Wi-Fi connection. For more information, see the documentation provided with the computer.



---

**NOTE:** If your computer does not support Wi-Fi, you are not able to use Wi-Fi Direct.

---

3. From the computer, connect to a new network. Use the process you normally use to connect to a new wireless network or hotspot. Choose the Wi-Fi Direct name from the list of wireless networks shown such as DIRECT-\*\*- HP ENVY-5660 (where \*\* are the unique characters to identify your printer and XXXX is the printer model located on the printer).

Enter the Wi-Fi Direct password when prompted.

4. Proceed to step 5 if the printer has been installed and connected to the computer over a wireless network. If the printer has been installed and connected to your computer with a USB cable, follow the steps below to install the printer software using the HP Wi-Fi Direct connection.
  - a. Depending on your operating system, do one of the following:
    - **Windows 8.1:** Click the down arrow in lower left corner of the Start screen, select the printer name, and then click **Utilities**.
    - **Windows 8:** Right-click an empty area on the Start screen, click **All Apps** on the app bar, select the printer name, and then click **Utilities**.
    - **Windows 7, Windows Vista, and Windows XP:** From the computer desktop, click **Start**, select **All Programs**, click **HP**, click the folder of your printer.
  - b. Click **Printer Setup & Software**, and then select **Connect a new printer**.
  - c. When the **Connection Options** software screen appears, select **Wireless**.  
Select your HP printer software from the list of detected printers.
  - d. Follow the on-screen instructions.
5. Print your document.

#### To print from a wireless-capable computer (OS X)

1. Make sure you have turned on Wi-Fi Direct on the printer.
2. Turn on Wi-Fi on the computer.  
For more information, see the documentation provided by Apple.
3. Click the Wi-Fi icon and choose the Wi-Fi Direct name, such as DIRECT-\*\*- HP ENVY-5660 (where \*\* are the unique characters to identify your printer and XXXX is the printer model located on the printer).  
If Wi-Fi Direct is turned on with security, enter the password when prompted.
4. Add the printer.
  - a. Open **System Preferences**.
  - b. Depending on your operating system, click **Print & Fax**, **Print & Scan**, or **Printers & Scanners** in the **Hardware** section.
  - c. Click + below the list of printers at the left.
  - d. Select the printer from the list of detected printers (the word “Bonjour” is listed the right column beside the printer name), and click **Add**.

 [Click here](#) for online troubleshooting for Wi-Fi Direct, or for more help with setting up Wi-Fi Direct.  
At this time, this website might not be available in all languages.

## Change network settings

From the printer control panel, you can set up and manage your printer wireless connection and perform a variety of network management tasks. This includes viewing and changing network settings, restoring network defaults, and turning the wireless function on or off.

---

**⚠ CAUTION:** Network settings are provided for your convenience. However, unless you are an advanced user, you should not change some of these settings (such as the link speed, IP settings, default gateway, and firewall settings).

---

### To print the network configuration page

1. From the printer control panel, touch **Setup**.
2. Touch **Reports** and then touch **Network Configuration Report**.

### To change IP settings

The default IP setting for the IP settings is **Automatic**, which sets the IP settings automatically. If you are an advanced user and want to use different settings (such as the IP address, subnet mask, or the default gateway), you can change them manually.

---

**⚠ CAUTION:** Be careful when manually assigning an IP address. If you enter an invalid IP address during the installation, your network components cannot connect with the printer.

---

1. From the printer control panel, touch **Setup** and then touch **Network Setup**.
2. Touch **Wireless Settings**.
3. Touch **Advanced Settings**.
4. Touch **IP Settings**.
5. A message appears warning that changing the IP address removes the printer from the network. Touch **OK** to continue.
6. **Automatic** is selected by default. To change the settings manually, touch **Manual**, and then enter the appropriate information for the following settings:
  - **IP Address**
  - **Subnet Mask**
  - **Default Gateway**
  - **DNS Address**
7. Enter your changes, and then touch **Done**.
8. Touch **OK**.

# Advanced printer management tools (for networked printers)

To view or change some settings, you might need a password.

---

 **NOTE:** You can open and use the embedded Web server without being connected to the Internet. However, some features are not available.

---

This section contains the following topics:

- [Toolbox \(Windows\)](#)
- [HP Utility \(OS X\)](#)
- [Open the embedded Web server](#)
- [About cookies](#)

## Toolbox (Windows)

The Toolbox provides maintenance information about the printer.

---

 **NOTE:** The Toolbox can be installed from the HP Software CD if the computer meets the system requirements. System requirements can be found in the Readme file, which is available on the HP printer software CD provided with your printer.

---

### To open the Toolbox

1. Depending on your operating system, do one of the following:
  - **Windows 8.1:** Click the down arrow in lower left corner of the Start screen, and then select the printer name.
  - **Windows 8:** Right-click an empty area on the Start screen, click **All Apps** on the app bar, and then select the printer name.
  - **Windows 7, Windows Vista, and Windows XP:** From the computer desktop, click **Start**, select **All Programs**, click **HP**, click the folder for the printer, and then select the icon with the printer's name.
2. Click **Print & Scan**.
3. Click **Maintain Your Printer**.

## HP Utility (OS X)

HP Utility contains tools to configure print settings, calibrate the printer, order supplies online, and find website support information.

---

 **NOTE:** The features available in HP Utility vary depending on the selected printer.

---

Ink level warnings and indicators provide estimates for planning purposes only. When you receive a low-ink warning message, consider having a replacement cartridge available to avoid possible printing delays. You do not need to replace cartridges until the print quality becomes unacceptable.

---

Double-click HP Utility in the **Hewlett-Packard** folder in the **Applications** folder at the top level of the hard disk.

## Open the embedded Web server

You can access the embedded Web server via either the network or Wi-Fi Direct.

### To open the embedded Web server via network



---

**NOTE:** The printer must be on a network and must have an IP address. The IP address for the printer can be found by pressing the Wireless icon or by printing a network configuration page.

---

- In a supported Web browser on your computer, type the IP address or hostname that has been assigned to the printer.

For example, if the IP address is 192.168.0.12, type the following address into a Web browser: `http://192.168.0.12`.

### To open the embedded Web server using Wi-Fi Direct

1. From the Home screen, touch (**Wireless**) and then touch (**Settings**).
2. If the display shows that Wi-Fi Direct is **Off**, touch **Wi-Fi Direct** and then switch it on.
3. From your wireless computer, turn wireless on, search for and connect to the Wi-Fi Direct name, for example: DIRECT-\*\*- HP ENVY-5660 (where \*\* are the unique characters to identify your printer). Enter the Wi-Fi Direct password when prompted.
4. In a supported Web browser on your computer, type the following address: `http://192.168.223.1`.

## About cookies

The embedded Web server (EWS) places very small text files (cookies) on your hard drive when you are browsing. These files let the EWS recognize your computer the next time you visit. For example, if you have configured the EWS language, a cookie helps remember which language you have selected so that the next time you access the EWS, the pages are displayed in that language. Some cookies (such as the cookie that stores customer-specific preferences) are stored on the computer until you clear them manually.

You can configure your browser to accept all cookies, or you can configure it to alert you every time a cookie is offered, which allows you to decide which cookies to accept or refuse. You can also use your browser to remove unwanted cookies.



---

**NOTE:** Depending on your printer, if you disable cookies, you also disable one or more of the following features:

---

- Starting where you left the application (especially useful when using setup wizards)
- Remembering the EWS browser language setting
- Personalizing the EWS Home page

For information about how to change your privacy and cookie settings and how to view or delete cookies, see the documentation available with your Web browser.

## Tips for setting up and using a networked printer

Use the following tips to set up and use a networked printer:

- When setting up the wireless networked printer, make sure your wireless router is powered on. The printer searches for wireless routers, then lists the detected network names on the display.



---

**NOTE:** If your printer has not been setup with a wireless connection, touch **Wireless** and then touch **Settings** on the printer display to start the Wireless Setup Wizard.

---

- To check the wireless connection on the printer, touch the **Wireless** on the control panel to open the Wireless Summary menu. If it shows **Wireless Off** or **Not Connected**, touch **Settings** and then touch **Wireless Setup Wizard**. Follow the on-screen instructions to set up your printer wireless connection.
- If your computer is connected to a Virtual Private Network (VPN), you need to disconnect from the VPN before you can access any other device on your network, including the printer.
- Learn more about configuring your network and the printer for wireless printing. [Click here to go online for more information.](#)
- Learn how to find your network security settings. [Click here to go online for more information.](#)
- Learn about the Print and Scan Doctor (Windows only) and other troubleshooting tips. [Click here to go online for more information.](#)
- Learn how to change from a USB to wireless connection. [Click here to go online for more information.](#)
- Learn how to work with your firewall and anti-virus programs during printer setup. [Click here to go online for more information.](#)

---

# 8 Solve a problem

This section contains the following topics:

- [Jams and paper-feed issues](#)
- [Ink cartridge issues](#)
- [Printing issues](#)
- [Copy issues](#)
- [Scan issues](#)
- [Network and connection issues](#)
- [Printer hardware issues](#)
- [HP support](#)



# Jams and paper-feed issues

What do you want to do?

## Clear a paper jam

<a href="#">Solve paper jam issues.</a>	Use an HP online troubleshooting wizard  Instructions for clearing the jam in the printer or in the automatic document feeder and resolving issues with paper or the paper feed.
---	--

 **NOTE:** The HP online troubleshooting wizards may not be available in all languages.

## Read general instructions in the Help for clearing paper jams

Paper jams can occur in several locations inside the printer.

 **CAUTION:** To prevent possible damage to the printhead, clear paper jams as soon as possible.

### To clear an internal paper jam

 **CAUTION:** Avoid pulling jammed paper from the front of the printer. Instead follow the steps below to clear the jam. Pulling out jammed paper from the front of the printer might cause the paper to tear and leave torn pieces inside the printer; this could result in more jams later.

1. Press the  (**Power** button) to turn the printer off.
2. Open the ink cartridge access door.

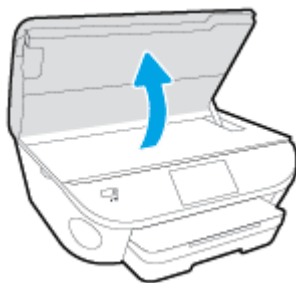

3. Check the paper path inside the printer.
  - a. Lift the handle of the paper path cover and remove the cover.

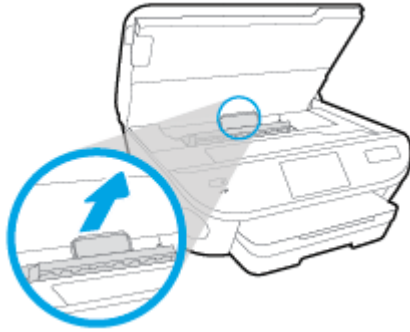

- b. Locate any jammed paper inside the printer, grasp it with both hands and pull it towards you.

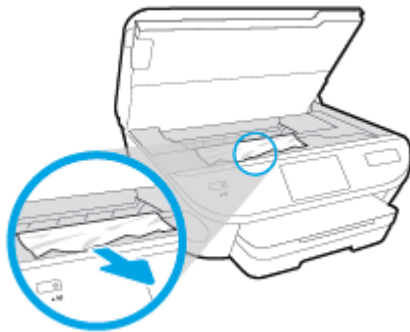

- 
- ⚠ CAUTION:** If the paper tears when you are removing it from the rollers, check the rollers and wheels for torn pieces of paper that might be remaining inside the printer.

If you do not remove all the pieces of paper from the printer, more paper jams are likely to occur.

---

- c. Reinsert the paper path cover until it snaps into place.
4. If the problem is not resolved, check the print carriage area inside the printer.

- 
- ⚠ CAUTION:** During the process, avoid touching the cable attached to the print carriage.
- 

- a. If there is any jammed paper, move the print carriage to the far right of the printer, grasp the jammed paper with both hands, and then pull it towards you.

- 
- ⚠ CAUTION:** If the paper tears when you are removing it from the rollers, check the rollers and wheels for torn pieces of paper that might be remaining inside the printer.

If you do not remove all the pieces of paper from the printer, more paper jams are likely to occur.

---

- b. Move the carriage to the far left of the printer, and do the same as in the previous step to remove any torn pieces of paper.
5. Close the ink cartridge access door.
  6. If the problem is still not resolved, check the tray area.
    - a. Pull out the input tray to extend it.



- b. Carefully turn the printer on its side to expose the bottom of the printer.
- c. Check the gap in the printer where the input tray was. If there is any jammed paper, reach into the gap, grasp the paper with both hands and pull it towards you.

---

**⚠ CAUTION:** If the paper tears when you are removing it from the rollers, check the rollers and wheels for torn pieces of paper that might be remaining inside the printer.

If you do not remove all of the pieces of paper from the printer, more paper jams are likely to occur.

---

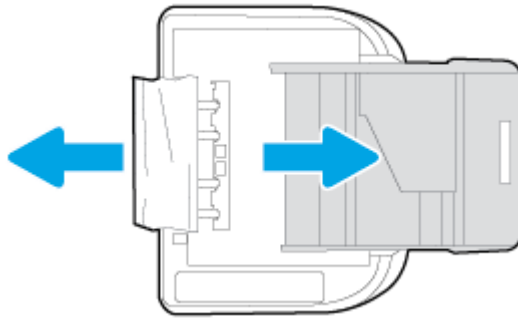

- d. Carefully turn the printer up again.
  - e. Push the paper tray back in.
7. Press the  (Power button) again to turn the printer on.

## Clear a print carriage jam

[Resolve a print carriage jam.](#)

Use an HP online troubleshooting wizard

If something is blocking the print carriage or it does not move easily, get step-by-step instructions.

---

 **NOTE:** The HP online troubleshooting wizards may not be available in all languages.

---

## Read general instructions in the Help for clearing a print carriage jams

1. Remove any objects, such as paper, that are blocking the print carriage.



---

**NOTE:** Do not use any tools or other devices to remove jammed paper. Always use caution when removing jammed paper from inside the printer

---

2. To get help from the print display, touch **Help** from the Home screen. Touch the directional button to navigate through help topics, touch **Troubleshoot and Support**, and then touch **Clear Carriage Jam**.

## Learn how to avoid paper jams

To help avoid paper jams, follow these guidelines.

- Remove printed papers from the output tray frequently.
- Make sure that you are printing with paper that is not wrinkled, folded, or damaged.
- Prevent curled or wrinkled paper by storing all unused paper flat in a resealable bag.
- Do not use paper that is too thick or too thin for the printer.
- Make sure that the trays are loaded correctly and are not too full. For more information, see [Load media on page 11](#).
- Ensure that paper loaded in the input tray lays flat and the edges are not bent or torn.
- Do not combine different paper types and paper sizes in the input tray; the entire stack of paper in the input tray must be the same size and type.
- Adjust the paper-width guides in the input tray to fit snugly against all paper. Make sure the paper-width guides do not bend the paper in the input tray.
- Do not force paper too far inside the input tray.
- If you are printing on both sides of a page, do not print highly saturated images on light weight paper.
- Use paper types that are recommended for the printer. For more information, see [Paper basics on page 8](#).
- If the printer is about to run out of paper, allow the printer to run out of paper first, and then add paper. Do not load paper when the printer is printing.

## Solve paper-feed problems

What kind of problem are you having?

- **Paper is not picked up from a tray**

- Make sure paper is loaded in the tray. For more information, see [Load media on page 11](#). Fan the paper before loading.
- Make sure the paper-width guides are set to the correct markings in the tray for the paper size you are loading. Also make sure the paper guides are snug, but not tight, against the stack.
- Make sure paper in the tray is not curled. Uncurl paper by bending it in the opposite direction of the curl.
- **Pages are skewing**
  - Make sure the paper loaded in the input tray is aligned to the paper-width guides. If needed, pull out the input tray from the printer and reload the paper correctly, making sure that the paper guides are aligned correctly.
  - Load paper into the printer only when it is not printing.
- **Multiple pages are being picked up**
  - Make sure the paper-width guides are set to the correct markings in the tray for the paper size you are loading. Also make sure the paper-width guides are snug, but not tight, against the stack.
  - Make sure the tray is not overloaded with paper.
  - Use HP paper for optimum performance and efficiency.

# Ink cartridge issues

First try removing and reinserting the ink cartridges. Make sure the cartridges are in the correct slots. If this does not work, clean the cartridge contacts. If your problem is still not resolved, see [Replace the cartridges on page 49](#) for more information.

## To clean cartridge contacts

**CAUTION:** The cleaning procedure should take only a few minutes. Make sure that the ink cartridges are reinstalled in the product as soon as possible. It is not recommended to leave the ink cartridges outside of the product longer than 30 minutes. This could result in damage to the ink cartridges.

1. Check that power is on.
2. Open the cartridge access door.



3. Remove the cartridge indicated in the error message.
4. Hold the ink cartridge by its sides with the bottom pointing up and locate the electrical contacts on the ink cartridge. The electrical contacts are the small gold-colored dots on the ink cartridge.

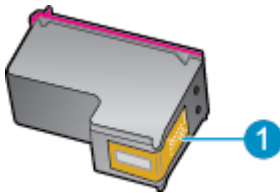

Feature	Description
1	Electrical contacts

5. Wipe only the contacts with a damp lint-free cloth.

**CAUTION:** Be careful to touch only the contacts, and do not smear any of the ink or other debris elsewhere on the cartridge.

6. On the inside of the printer, locate the contacts in the print carriage. The contacts look like a set of gold-colored bumps positioned to meet the contacts on the ink cartridge.
7. Use a dry swab or lint-free cloth to wipe the contacts.
8. Reinstall the ink cartridge.

9. Close the access door, and check if the error message has gone away.
10. If you still receive the error message, turn the product off, and then on again.



---

**NOTE:** If one ink cartridge is causing problems, you can remove it and use the single-cartridge mode to operate the HP ENVY 5660 series with only one cartridge.

---

# Printing issues

What do you want to do?

## Fix problems with page not printing (unable to print)

<a href="#">HP Print and Scan Doctor</a>	The HP Print and Scan Doctor is a utility that will try to diagnose and fix the issue automatically.
<a href="#">Troubleshoot problems with print jobs not printing.</a>	Use an HP online troubleshooting wizard Get step-by-step instructions if the printer is not responding or printing.

 **NOTE:** The HP Print and Scan Doctor and the HP online troubleshooting wizards may not be available in all languages.

## Read general instructions in the Help for unable to print issues

### Resolve print issues

 **NOTE:** Make sure that the printer is turned on and that there is paper in the tray. If you are still unable to print, try the following in order:

1. Check for error messages from the printer display and resolve them by following the onscreen instructions.
2. If your computer is connected to the printer with a USB cable, disconnect and reconnect the USB cable. If your computer is connected to the printer with a wireless connection, confirm that the connection is working.
3. Verify that the printer is not paused or offline.

#### To verify that the printer is not paused or offline

- a. Depending on your operating system, do one of the following:
  - **Windows 8.1 and Windows 8:** Point to or tap the upper-right corner of the screen to open the Charms bar, click the **Settings** icon, click or tap **Control Panel**, and then click or tap **View devices and printers**.
  - **Windows 7:** From the Windows **Start** menu, click **Devices and Printers**.
  - **Windows Vista:** From the Windows **Start** menu, click **Control Panel**, and then click **Printers**.
  - **Windows XP:** From the Windows **Start** menu, click **Control Panel**, and then click **Printers and Faxes**.
- b. Either double-click the icon for your printer or right-click the icon for your printer and select **See what's printing** to open the print queue.
- c. On the **Printer** menu, make sure there are no check marks next to **Pause Printing** or **Use Printer Offline**.
- d. If you made any changes, try to print again.



4. Verify that the printer is set as the default printer.

#### To verify that the printer is set as the default printer

- a. Depending upon your operating system, do one of the following:
    - **Windows 8.1 and Windows 8:** Point to or tap the upper-right corner of the screen to open the Charms bar, click the **Settings** icon, click or tap **Control Panel**, and then click or tap **View devices and printers**.
    - **Windows 7:** From the Windows **Start** menu, click **Devices and Printers**.
    - **Windows Vista:** From the Windows **Start** menu, click **Control Panel**, and then click **Printers**.
    - **Windows XP:** From the Windows **Start** menu, click **Control Panel**, and then click **Printers and Faxes**.
  - b. Make sure the correct printer is set as the default printer.

The default printer has a check mark in a black or green circle next to it.
  - c. If the wrong printer is set as the default printer, right-click the correct printer and select **Set as Default Printer**.
  - d. Try using your printer again.
5. Restart the print spooler.

#### To restart the print spooler

- a. Depending upon your operating system, do one of the following:
  - Windows 8.1 and Windows 8**
    - i. Point to or tap the upper-right corner of the screen to open the Charms bar, and then click the **Settings** icon.
    - ii. Click or tap **Control Panel**, and then click or tap **System and Security**.
    - iii. Click or tap **Administrative Tools**, and then double-click or double-tap **Services**.
    - iv. Right-click or touch and hold **Print Spooler**, and then click **Properties**.
    - v. On the **General** tab, next to **Startup type**, make sure that **Automatic** is selected.
    - vi. If the service is not already running, under **Service status**, click or tap **Start**, and then click or tap **OK**.

#### Windows 7

- i. From the Windows **Start** menu, click **Control Panel**, **System and Security**, and then **Administrative Tools**.
- ii. Double-click **Services**.
- iii. Right-click the **Print Spooler**, and then click **Properties**.

- iv. On the **General** tab, next to **Startup type**, make sure that **Automatic** is selected.
- v. If the service is not already running, under **Service status**, click **Start**, and then click **OK**.

### Windows Vista

- i. From the Windows **Start** menu, click **Control Panel, System and Maintenance, Administrative Tools**.
- ii. Double-click **Services**.
- iii. Right-click the **Print Spooler service**, and then click **Properties**.
- iv. On the **General** tab, next to **Startup type**, make sure that **Automatic** is selected.
- v. If the service is not already running, under **Service status**, click **Start**, and then click **OK**.

### Windows XP

- i. From the Windows **Start** menu, right click **My Computer**.
  - ii. Click **Manage**, and then click **Services and Applications**.
  - iii. Double-click **Services**, and then select **Print Spooler**.
  - iv. Right-click **Print Spooler**, and click **Restart** to restart the service.
- b. Make sure the correct printer is set as the default printer.
- The default printer has a check mark in a black or green circle next to it.
- c. If the wrong printer is set as the default printer, right-click the correct printer and select **Set as Default Printer**.
- d. Try using your printer again.
6. Restart the computer.
7. Clear the print queue.

### To clear the print queue

- a. Depending upon your operating system, do one of the following:
  - **Windows 8.1 and Windows 8:** Point to or tap the upper-right corner of the screen to open the Charms bar, click the **Settings** icon, click or tap **Control Panel**, and then click or tap **View devices and printers**.
  - **Windows 7:** From the Windows **Start** menu, click **Devices and Printers**.
  - **Windows Vista:** From the Windows **Start** menu, click **Control Panel**, and then click **Printers**.
  - **Windows XP:** From the Windows **Start** menu, click **Control Panel**, and then click **Printers and Faxes**.
- b. Double-click the icon for your printer to open the print queue.

- c. On the **Printer** menu, click **Cancel all documents** or **Purge Print Document**, and then click **Yes** to confirm.
- d. If there are still documents in the queue, restart the computer and try printing again after the computer has restarted.
- e. Check the print queue again to make sure it is clear, and then try to print again.

### To check the power connection and reset the printer

1. Make sure the power cord is firmly connected to the printer.

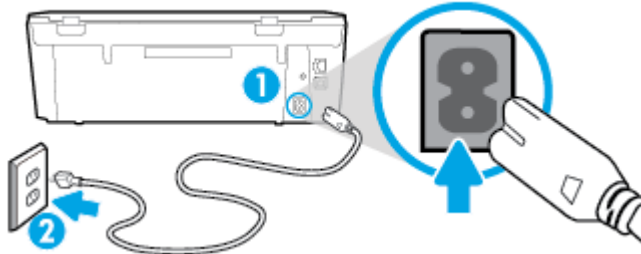

1	Power connection to the printer
2	Connection to a power outlet

2. Look inside the printer and check for a green light indicating the printer is receiving electrical power. If it is not lit, make sure the cord is fully plugged into the printer, or connect to another power outlet.
3. Look at the On button located on the printer. If it is not lit, the printer is turned off. Press the On button to turn on the printer.

 **NOTE:** If the printer is not receiving electrical power, connect it to another power outlet.

4. With the printer turned on, disconnect the power cord from the side of the printer under the cartridge access door.
5. Unplug the power cord from the wall outlet.
6. Wait at least 15 seconds.
7. Plug the power cord back into the wall outlet.
8. Reconnect the power cord to the side of the printer under the cartridge access door.
9. If the printer does not turn on by itself, press the On button to turn on the printer.
10. Try using the printer again.

## Fix print quality issues

[Step-by-step instructions for resolving most print quality issues.](#)

Troubleshoot print quality issues online

## Read general instructions in the Help for resolving print quality issues

 **NOTE:** To avoid print quality problems, always turn the printer off using the **On** button, and wait until the **On** button light goes out before you pull the plug or turn off a power strip. This allows the printer to move the cartridges to a capped position, where they are protected from drying out.

### To improve print quality

1. Make sure you are using original HP ink cartridges.
2. Check the printer software to make sure you have selected the appropriate paper type from the **Media** drop-down list and print quality from the **Quality Settings** drop-down list.
  - In the printer software, click **Print & Scan** and then click **Set Preferences** to access the print properties.
3. Check the estimated ink levels to determine if the cartridges are low on ink. For more information, see [Check the estimated ink levels on page 48](#). If the ink cartridges are low on ink consider replacing them.
4. Align the cartridges.

### To align the cartridges from the printer software

 **NOTE:** Aligning the cartridges ensures the high-quality output. The HP All-in-One prompts you to align the cartridges every time you install a new cartridge. If you remove and reinstall the same ink cartridge, the HP All-in-One will not prompt you to align the ink cartridges. The HP All-in-One remembers the alignment values for that ink cartridge, so you do not need to realign the ink cartridges.

- a. Load letter or A4 unused plain white paper into the paper tray.
- b. Depending on your operating system, do one of the following to open the printer software:
- c. In the printer software, click **Print & Scan**, and then click **Maintain Your Printer** to access the **Printer Toolbox**.
- d. In **Printer Toolbox**, click **Align Ink Cartridges** on the **Device Services** tab. The printer prints an alignment sheet.
- e. Load the cartridge alignment sheet print side down on the right front corner of the scanner glass.

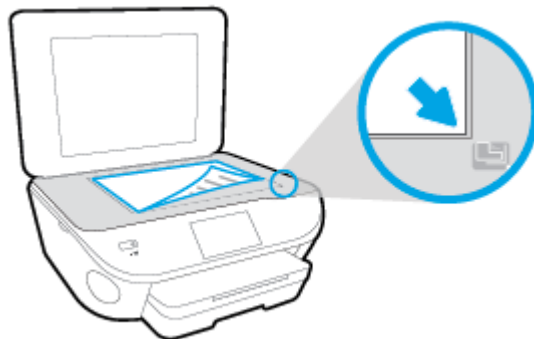

- f. Follow the instructions on the printer display to align the cartridges. Recycle or discard the cartridge alignment sheet.

### To align the cartridges from the printer display

- a. Load Letter or A4 unused plain white paper into the input tray.
  - b. From the printer control panel display, touch **Setup**.
  - c. Touch **Printer Maintenance**, select **Align Printhead**, and then follow the on-screen instructions.
5. Print a diagnostics page if the cartridges are not low on ink.

### To print a diagnostics page from the printer software

- a. Load letter or A4 unused plain white paper into the paper tray.
- b. Depending on your operating system, do one of the following to open the printer software:
- c. In the printer software, click **Print & Scan**, and then click **Maintain Your Printer** to access the printer toolbox.
- d. Click **Print Diagnostic Information** on the **Device Reports** tab to print a diagnostics page. Review the blue, magenta, yellow, and black boxes on the diagnostics page. If you are seeing streaks in the color and black boxes, or no ink in portions of the boxes, then automatically clean the cartridges.

### To print a diagnostics page from the printer display

- a. Load letter or A4 unused plain white paper into the paper tray.
  - b. From the printer control panel, touch **Setup**.
  - c. Touch **Reports**.
  - d. Touch **Print Quality Report**.
6. Clean the ink cartridges automatically, if the diagnostic page shows streaks or missing portions of the color and black boxes.

### To clean the cartridges from the printer software

- a. Load letter or A4 unused plain white paper into the paper tray.
- b. Depending on your operating system, do one of the following to open the printer software:
  - **Windows 8.1:** Click the down arrow in lower left corner of the Start screen, and then select the printer name.
  - **Windows 8:** Right-click an empty area on the Start screen, click **All Apps** on the app bar, and then select the printer name.
  - **Windows 7, Windows Vista, and Windows XP:** From the computer desktop, click **Start**, select **All Programs**, click **HP**, click the folder for the printer, and then select the icon with the printer's name.
- c. In the printer software, click **Print & Scan** and then click **Maintain Your Printer** to access the **Printer Toolbox**.
- d. Click **Clean Ink Cartridges** on the **Device Services** tab. Follow the on-screen instructions.

### To clean the cartridges from the printer display

- a. Load Letter or A4 unused plain white paper into the input tray.
- b. From the printer control panel display, touch **Setup**.
- c. Touch **Printer Maintenance**, select **Clean Printhead**, and then follow the on-screen instructions.

If cleaning the printhead does not solve the problem, contact HP support. Go to [www.hp.com/support](http://www.hp.com/support). This website provides information and utilities that can help you correct many common printer problems. If prompted, select your country/region, and then click **All HP Contacts** for information on calling for technical support.

### To improve print quality

1. Make sure you are using original HP cartridges.
2. Make sure you have selected the appropriate paper type and print quality in the **Print** dialog.
3. Check the estimated ink levels to determine if the cartridges are low on ink.  
Consider replacing the print cartridges if they are low on ink.
4. Align the printer cartridges

### To align print cartridges from the software

- a. Load Letter or A4 plain, white paper in the paper tray.
- b. Open HP Utility.



---

**NOTE:** HP Utility is located in the **Hewlett-Packard** folder in the **Applications** folder at the top level of the hard disk.

---

- c. Select the HP ENVY 5660 series from the list of devices at the left of the window.
  - d. Click **Align**.
  - e. Click **Align** and follow the on-screen instructions.
  - f. Click **All Settings** to return to the **Information and Support** pane.
5. Print a test page.

### To print a test page

- a. Load Letter or A4 plain, white paper in the paper tray.
- b. Open HP Utility.



---

**NOTE:** HP Utility is located in the **Hewlett-Packard** folder in the **Applications** folder at the top level of the hard disk.

---

- c. Select the HP ENVY 5660 series from the list of devices at the left of the window.

- d. Click **Test Page**.
  - e. Click the **Print Test Page** button, and follow the on-screen instructions.  
Check the test page for jagged lines in the text or streaks in the text and colored boxes. If you are seeing jagged lines, or streaks, or no ink in portions of the boxes, then automatically clean the cartridges.
6. If the diagnostic page shows streaks or missing portions of the text or colored boxes, clean the print cartridges automatically.

#### To automatically clean the print head

- a. Load Letter or A4 plain, white paper in the paper tray.
- b. Open HP Utility.

---

 **NOTE:** HP Utility is located in the **Hewlett-Packard** folder in the **Applications** folder at the top level of the hard disk.

---

- c. Select the HP ENVY 5660 series from the list of devices at the left of the window.
- d. Click **Clean Printheads**.
- e. Click **Clean**, and follow the on-screen instructions.

---

 **CAUTION:** Clean the print head only when necessary. Unnecessary cleaning wastes ink and shortens the life of the print head.

---

 **NOTE:** If print quality still seems poor after you complete cleaning, try aligning the printer. If print quality problems persist after cleaning and aligning, contact HP support.

---

- f. Click **All Settings** to return to the **Information and Support** pane.

### Fix ink smears on printouts

If a printout shows smears of ink, for subsequent prints, try using the Clean Ink Smear function from the printer display. This process takes several minutes to complete. Full-size plain paper needs to be loaded and will be moved back and forth during the cleaning. Mechanical noises are normal at this time.

1. Load Letter or A4 unused plain white paper into the input tray.
2. From the printer control panel display, touch **Setup**.
3. Touch **Printer Maintenance**, select the desired option, and then follow the on-screen instructions.

---

 **NOTE:** You can also do the same from the HP printer software or embedded web server (EWS). To access the software or EWS, see [Open the HP printer software \(Windows\) on page 16](#) or [Open the embedded Web server on page 64](#).

---

# Copy issues

---

[Troubleshoot copy problems.](#)

Use an HP online troubleshooting wizard

Get step-by-step instructions if the printer does not create a copy, or if your printouts are low quality.

---



**NOTE:** The HP online troubleshooting wizards may not be available in all languages.

---

[Tips for copy and scan success on page 46](#)



## Scan issues

<a href="#">HP Print and Scan Doctor</a>	The HP Print and Scan Doctor is a utility that will try to diagnose and fix the issue automatically.
<a href="#">Solve scan problems</a>	Use an HP online troubleshooting wizard Get step-by-step instructions if you cannot create a scan or if your scans are low quality.

 **NOTE:** The HP Print and Scan Doctor and the HP online troubleshooting wizards may not be available in all languages.

[Tips for copy and scan success on page 46](#)

# Network and connection issues

What do you want to do?

## Fix wireless connection



Choose one of the following troubleshooting options.

<a href="#">HP Print and Scan Doctor</a>	The HP Print and Scan Doctor is a utility that will try to diagnose and fix the issue automatically.
Use an HP online troubleshooting wizard	<a href="#">Troubleshoot a firewall or antivirus issue</a> , if you suspect that it is preventing your computer from connecting to the printer. <ul style="list-style-type: none"><li>• <a href="#">Troubleshoot your wireless problem</a>, whether your printer has never been connected or it was connected and is no longer working.</li><li>• <a href="#">Troubleshoot a firewall or antivirus issue</a>, if you suspect that it is preventing your computer from connecting to the printer.</li></ul>

 **NOTE:** The HP Print and Scan Doctor and the HP online troubleshooting wizards may not be available in all languages.

## Read general instructions in the Help for wireless troubleshooting

Check the network configuration or print the wireless test report to assist in diagnosing network connection issues.

1. From the Home screen, touch  (**Wireless**) and then touch  (**Settings**).
2. Touch **Print Reports**, and then touch **Display Network Configuration** or **Print Wireless Test Report**.

## Find network settings for wireless connection

Choose one of the following troubleshooting options.

<a href="#">HP Print and Scan Doctor</a>	The HP Print and Scan Doctor is a utility that can tell you the network name (SSID) and password (network key).
<a href="#">Use an HP online troubleshooting wizard</a>	Learn how to find your network name (SSID) and wireless password.

 **NOTE:** The HP Print and Scan Doctor and the HP online troubleshooting wizards may not be available in all languages.

## Fix Wi-Fi Direct connection

<a href="#">Use an HP online troubleshooting wizard</a>	Troubleshoot your Wi-Fi Direct problem or learn how to configure Wi-Fi Direct.
---	--

 **NOTE:** The HP online troubleshooting wizards may not be available in all languages.

## Read general instructions in the Help for Wi-Fi Direct troubleshooting

1. Check the printer to confirm that Wi-Fi Direct is turned on:
  - ▲ From the printer control panel, touch  (Wi-Fi Direct).
2. From your wireless computer or mobile device, turn on the Wi-Fi connection, and then search for and connect to the Wi-Fi Direct name of your printer.
3. Enter the Wi-Fi Direct password when prompted.
4. If you are using a mobile device, make sure you have installed a compatible printing app. For more information about mobile printing, visit [www.hp.com/global/us/en/eprint/mobile\\_printing\\_apps.html](http://www.hp.com/global/us/en/eprint/mobile_printing_apps.html).

## Convert USB connection to wireless

Choose one of the following troubleshooting options.

<a href="#">HP Print and Scan Doctor</a>	The HP Print and Scan Doctor is a utility that will try to diagnose and fix the issue automatically.
<a href="#">Use an HP online troubleshooting wizard</a>	Convert a USB connection to wireless or Wi-Fi Direct.

 **NOTE:** The HP Print and Scan Doctor and the HP online troubleshooting wizards may not be available in all languages.

[Change the connection type on page 58](#)

## Printer hardware issues

 **TIP:** Run the [HP Print and Scan Doctor](#) to diagnose and automatically fix printing, scanning, and copying issues. The application is only available in some languages.

### To extract the automatic output tray extender manually

If the automatic output tray extender does not deploy automatically, you can extract it manually.

1. Remove the output tray from the printer.



2. On the bottom of the output tray, move the output tray lock to the unlocked position, and then shift the release lever to release the tray extender.

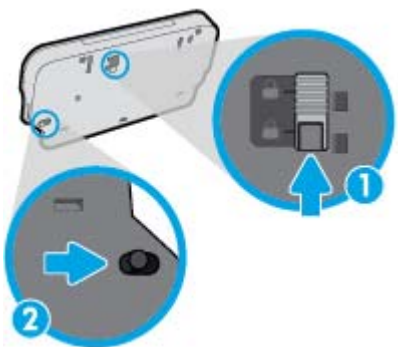

3. Insert the output tray back into the printer leaving the tray extender in the released position.

### The printer shuts down unexpectedly

- Check the power and power connections.
- Make sure the printer's power cord is connected firmly to a functioning power outlet.

### Printhead alignment fails

- If the alignment process fails, make sure you have loaded unused, plain white paper into the input tray. If you have colored paper loaded in the input tray when you align the ink cartridges, the alignment fails.
- If the alignment process fails repeatedly, you may need to clean the printhead, or you might have a defective sensor.
- If cleaning the printhead does not solve the problem, contact HP support. Go to [www.hp.com/support](http://www.hp.com/support). This website provides information and utilities that can help you correct many common printer problems. If prompted, select your country/region, and then click **All HP Contacts** for information on calling for technical support.

### Resolve printer failure.

- ▲ Turn the printer off, then on. If that does not resolve the problem, contact HP.

For more information about contacting HP support, see [HP support on page 88](#).

# HP support

- [Register printer](#)
- [Support process](#)
- [HP support by phone](#)
- [Additional warranty options](#)

## Register printer

By taking just a few quick minutes to register, you can enjoy quicker service, more efficient support, and product support alerts. If you did not register your printer while installing the software, you can register now at <http://www.register.hp.com>.

## Support process

If you have a problem, follow these steps:

1. Check the documentation that came with the printer.
2. Visit the HP online support website at [www.hp.com/support](http://www.hp.com/support).

HP online support is available to all HP customers. It is the fastest source for up-to-date product information and expert assistance, and includes the following features:

- Fast access to qualified online support specialists
  - Software and driver updates for the printer
  - Valuable troubleshooting information for common problems
  - Proactive printer updates, support alerts, and HP newsgrams that are available when you register the printer
3. Call HP support.

Support options and availability vary by printer, country/region, and language.

## HP support by phone

Phone support options and availability vary by product, country/region, and language.

This section contains the following topics:

- [Phone support period](#)
- [Placing a call](#)
- [Support phone numbers](#)
- [After the phone support period](#)

## Phone support period

One year of phone support is available in North America, Asia Pacific, and Latin America (including Mexico). To determine the duration of phone support in Europe, the Middle East, and Africa, go to [www.hp.com/support](http://www.hp.com/support). Standard phone company charges apply.

## Placing a call

Call HP support while you are in front of the computer and the printer. Be prepared to provide the following information:

- Product name (Located on the printer, such as HP ENVY 5660)
- Product number (located inside the cartridge access door)



- Serial number (located on the back or bottom of the printer)
- Messages that appear when the situation occurs
- Answers to these questions:
  - Has this situation happened before?
  - Can you recreate it?
  - Did you add any new hardware or software to your computer at about the time that this situation began?
  - Did anything else occur prior to this situation (such as a thunderstorm, the printer was moved, etc.)?

## Support phone numbers

For the most current HP list of telephone support numbers and call costs information, see [www.hp.com/support](http://www.hp.com/support).

## After the phone support period

After the phone support period, help is available from HP at an additional cost. Help may also be available at the HP online support website: [www.hp.com/support](http://www.hp.com/support). Contact your HP dealer or call the support phone number for your country/region to learn more about support options.

## Additional warranty options

Extended service plans are available for the HP ENVY 5660 series at additional costs. Go to [www.hp.com/support](http://www.hp.com/support), select your country/region and language, then explore the services and warranty area for information about the extended service plans.

---

# A Technical information

The technical specifications and international regulatory information for the HP ENVY 5660 series are provided in this section.

For additional specifications, see the printed documentation that came with the HP ENVY 5660 series.

This section contains the following topics:

- [Hewlett-Packard Company notices](#)
- [Specifications](#)
- [Environmental product stewardship program](#)
- [Regulatory information](#)



# Hewlett-Packard Company notices

The information contained herein is subject to change without notice.

All rights reserved. Reproduction, adaptation, or translation of this material is prohibited without prior written permission of Hewlett-Packard, except as allowed under the copyright laws. The only warranties for HP products and services are set forth in the express warranty statements accompanying such products and services. Nothing herein should be construed as constituting an additional warranty. HP shall not be liable for technical or editorial errors or omissions contained herein.

© 2014 Hewlett-Packard Development Company, L.P.

Microsoft®, Windows®, Windows® XP, Windows Vista®, Windows® 7, Windows® 8, and Windows® 8.1 are U.S. registered trademarks of Microsoft Corporation.

# Specifications

Technical specifications for the HP ENVY 5660 series are provided in this section. For more product specifications, see the Product Data Sheet at [www.hp.com/support](http://www.hp.com/support).

## System requirements

Software and system requirements are located in the Readme file.

For information about future operating system releases and support, visit the HP online support website at [www.hp.com/support](http://www.hp.com/support).

## Environmental specifications

- Recommended operating temperature range: 15°C to 32°C (59°F to 90°F)
- Allowable operating temperature range: 5°C to 40°C (41°F to 104°F)
- Humidity: 20% to 80% RH non-condensing (recommended); 25°C maximum dewpoint
- Non-operating (Storage) temperature range: -40°C to 60°C (-40°F to 140°F)
- In the presence of high electromagnetic fields, it is possible the output from the HP ENVY 5660 series may be slightly distorted.
- HP recommends using a USB cable less than or equal to 3 m (10 feet) in length to minimize injected noise due to potential high electromagnetic fields.

## Print specifications

- Print speeds vary according to the complexity of the document.
- Method: drop-on-demand thermal inkjet
- Language: PCL3 GUI

## Scan specifications

- Optical Resolution: up to 1200 dpi
- Hardware Resolution: up to 1200 x 1200 dpi
- Enhanced Resolution: up to 1200 x 1200 dpi
- Bitdepth: 24-bit color, 8-bit grayscale (256 levels of gray)
- Maximum scan size from glass: 21.6 x 29.7 cm (8.5 x 11.7 inches)
- Supported File Types: BMP, JPEG, PNG, TIFF, PDF
- Twain Version: 1.9

## Copy specifications

- Digital image processing
- Maximum number of copies varies by model.
- Copy speeds vary according to the complexity of the document and model.

## Cartridge yield

Visit [www.hp.com/go/learnaboutsupplies](http://www.hp.com/go/learnaboutsupplies) for more information on estimated cartridge yields.

## Print resolution

**Table A-1 Print resolution**

<b>Draft mode</b>	<ul style="list-style-type: none"><li>• Color Input/Black Render: 300x300dpi</li><li>• Output (Black/Color): Automatic</li></ul>
<b>Normal mode</b>	<ul style="list-style-type: none"><li>• Color Input/Black Render: 600x600dpi</li><li>• Output (Black/Color): Automatic</li></ul>
<b>Plain-Best mode</b>	<ul style="list-style-type: none"><li>• Color Input/Black Render: 600x600dpi</li><li>• Output (Black/Color): Automatic</li></ul>
<b>Photo-Best mode</b>	<ul style="list-style-type: none"><li>• Color Input/Black Render: 600x600dpi</li><li>• Output (Black/Color): Automatic</li></ul>
<b>Max DPI mode</b>	<ul style="list-style-type: none"><li>• Color Input/Black Render: 1200x1200dpi</li><li>• Output: Automatic (Black/Color), 4800x1200 optimized dpi (Photo Paper, Color)</li></ul>

# Environmental product stewardship program

Hewlett-Packard is committed to providing quality products in an environmentally sound manner. Design for recycling has been incorporated into this product. The number of materials has been kept to a minimum while ensuring proper functionality and reliability. Dissimilar materials have been designed to separate easily. Fasteners and other connections are easy to locate, access, and remove using common tools. High priority parts are designed for efficient disassembly and repair.

For more information, visit HP's Commitment to the Environment website at:

[www.hp.com/hpinfo/globalcitizenship/environment/index.html](http://www.hp.com/hpinfo/globalcitizenship/environment/index.html).

This section contains the following topics:

- [Eco-Tips](#)
- [Paper use](#)
- [Plastics](#)
- [Material safety data sheets](#)
- [HP inkjet supplies recycling program](#)
- [Power consumption](#)
- [Disposal of waste equipment by users](#)
- [Chemical substances](#)
- [Battery disposal in the Taiwan](#)
- [Battery notice for Brazil](#)
- [California Perchlorate Material Notice](#)
- [EPEAT](#)
- [Toxic and hazardous substance table \(China\)](#)
- [Restriction of hazardous substance \(Ukraine\)](#)
- [Restriction of hazardous substance \(India\)](#)

## Eco-Tips

HP is committed to helping customers reduce their environmental footprint. Please visit the HP Environmental Programs and Initiatives website for more information on HP's environmental initiatives.

[www.hp.com/hpinfo/globalcitizenship/environment/](http://www.hp.com/hpinfo/globalcitizenship/environment/)

## Paper use

This product is suited for the use of recycled paper according to DIN 19309 and EN 12281:2002.

## Plastics

Plastic parts over 25 grams are marked according to international standards that enhance the ability to identify plastics for recycling purposes at the end of product life.

## Material safety data sheets

Material safety data sheets (MSDS) can be obtained from the HP website at:

[www.hp.com/go/msds](http://www.hp.com/go/msds)

## HP inkjet supplies recycling program

HP is committed to protecting the environment. The HP Inkjet Supplies Recycling Program is available in many countries/regions, and lets you recycle used print cartridges and ink cartridges free of charge. For more information, go to the following website:

[www.hp.com/hpinfo/globalcitizenship/environment/recycle/](http://www.hp.com/hpinfo/globalcitizenship/environment/recycle/)

## Power consumption

Hewlett-Packard printing and imaging equipment marked with the ENERGY STAR® logo is qualified to the U.S. Environmental Protection Agency's ENERGY STAR specifications for imaging equipment. The following mark will appear on ENERGY STAR qualified imaging products:



Additional ENERGY STAR qualified imaging product model information is listed at: [www.hp.com/go/energystar](http://www.hp.com/go/energystar)

## Disposal of waste equipment by users



This symbol means do not dispose of your product with your other household waste. Instead, you should protect human health and the environment by handing over your waste equipment to a designated collection point for the recycling of waste electrical and electronic equipment. For more information, please contact your household waste disposal service, or go to <http://www.hp.com/recycle>.

## Chemical substances

HP is committed to providing our customers with information about the chemical substances in our products as needed to comply with legal requirements such as REACH (*Regulation EC No 1907/2006 of the European Parliament and the Council*). A chemical information report for this product can be found at: [www.hp.com/go/reach](http://www.hp.com/go/reach).

## Battery disposal in the Taiwan



廢電池請回收

## Battery notice for Brazil

A bateria deste equipamento não foi projetada para ser removida pelo cliente.

## California Perchlorate Material Notice

### **California Perchlorate Material Notice**

Perchlorate material - special handling may apply. See:  
<http://www.dtsc.ca.gov/hazardouswaste/perchlorate/>

This product's real-time clock battery or coin cell battery may contain perchlorate and may require special handling when recycled or disposed of in California.

## EPEAT

### **EPEAT**

Most HP products are designed to meet EPEAT. EPEAT is a comprehensive environmental rating that helps identify greener electronics equipment. For more information on EPEAT go to [www.epeat.net](http://www.epeat.net). For information on HP's EPEAT registered products go to [www.hp.com/hpinfo/globalcitizenship/environment/pdf/epeat\\_printers.pdf](http://www.hp.com/hpinfo/globalcitizenship/environment/pdf/epeat_printers.pdf).

## Toxic and hazardous substance table (China)

有毒有害物质表						
根据中国《电子信息产品污染控制管理办法》						
零件描述	有毒有害物质和元素					
	铅	汞	镉	六价铬	多溴联苯	多溴联苯醚
外壳和托座*	0	0	0	0	0	0
电线*	0	0	0	0	0	0
印刷电路板*	X	0	0	0	0	0
打印系统*	X	0	0	0	0	0
显示屏*	X	0	0	0	0	0
喷墨打印机墨盒*	0	0	0	0	0	0
驱动光盘*	X	0	0	0	0	0
扫描仪*	X	X	0	0	0	0
网络配件*	X	0	0	0	0	0
电池板*	X	0	0	0	0	0
自动双面打印系统*	0	0	0	0	0	0
外部电源*	X	0	0	0	0	0

0: 指此零件的所有均一材质中包含的这种有毒有害物质, 含量低于SJ/T11363-2006的限制  
X: 指此零件使用的均一材质中至少有一种包含的这种有毒有害物质, 含量高于SJ/T11363-2006的限制  
注: 环保使用期限的参考标识取决于产品正常工作的温度和湿度等条件  
\*以上只适用于使用这些零件的产品

## Restriction of hazardous substance (Ukraine)

### Технічний регламент щодо обмеження використання небезпечних речовин (Україна)

Обладнання відповідає вимогам Технічного регламенту щодо обмеження використання деяких небезпечних речовин в електричному та електронному обладнанні, затвердженого постановою Кабінету Міністрів України від 3 грудня 2008 № 1057

## Restriction of hazardous substance (India)

### Restriction of hazardous substances (India)

This product complies with the "India E-waste (Management and Handling) Rule 2011" and prohibits use of lead, mercury, hexavalent chromium, polybrominated biphenyls or polybrominated diphenyl ethers in concentrations exceeding 0.1 weight % and 0.01 weight % for cadmium, except for the exemptions set in Schedule 2 of the Rule.

## Regulatory information

The printer meets product requirements from regulatory agencies in your country/region.

This section contains the following topics:

- [Regulatory model identification number](#)
- [FCC statement](#)
- [Notice to users in Korea](#)
- [VCCI \(Class B\) compliance statement for users in Japan](#)
- [Notice to users in Japan about the power cord](#)
- [GS Statement \(Germany\)](#)
- [Declaration of conformity](#)
- [Regulatory information for wireless products](#)

### Regulatory model identification number

For regulatory identification purposes, your product is assigned a Regulatory Model Number. The Regulatory Model Number for your product is SDGOB-1401-01. This regulatory number should not be confused with the marketing name (HP ENVY 5660 e-All-in-One series, etc.) or product numbers (F8B04A, F8B06A, etc.).



## FCC statement

### FCC statement

The United States Federal Communications Commission (in 47 CFR 15.105) has specified that the following notice be brought to the attention of users of this product.

This equipment has been tested and found to comply with the limits for a Class B digital device, pursuant to Part 15 of the FCC Rules. These limits are designed to provide reasonable protection against harmful interference in a residential installation. This equipment generates, uses and can radiate radio frequency energy and, if not installed and used in accordance with the instructions, may cause harmful interference to radio communications. However, there is no guarantee that interference will not occur in a particular installation. If this equipment does cause harmful interference to radio or television reception, which can be determined by turning the equipment off and on, the user is encouraged to try to correct the interference by one or more of the following measures:

- Reorient or relocate the receiving antenna.
- Increase the separation between the equipment and the receiver.
- Connect the equipment into an outlet on a circuit different from that to which the receiver is connected.
- Consult the dealer or an experienced radio/TV technician for help.

For further information, contact:

Manager of Corporate Product Regulations  
Hewlett-Packard Company  
3000 Hanover Street  
Palo Alto, Ca 94304  
(650) 857-1501

Modifications (part 15.21)

The FCC requires the user to be notified that any changes or modifications made to this device that are not expressly approved by HP may void the user's authority to operate the equipment.

This device complies with Part 15 of the FCC Rules. Operation is subject to the following two conditions: (1) this device may not cause harmful interference, and (2) this device must accept any interference received, including interference that may cause undesired operation.

## Notice to users in Korea

B 급 기기 (가정용 방송통신기기)	이 기기는 가정용(B급)으로 전자파적합등록을 한 기기로서 주로 가정에서 사용하는 것을 목적으로 하며, 모든 지역에서 사용할 수 있습니다.
------------------------	--

## VCCI (Class B) compliance statement for users in Japan

この装置は、クラスB情報技術装置です。この装置は、家庭環境で使用することを目的としていますが、この装置がラジオやテレビジョン受信機に近接して使用されると、受信障害を引き起こすことがあります。取扱説明書に従って正しい取り扱いをして下さい。

VCCI-B

## Notice to users in Japan about the power cord

製品には、同梱された電源コードをお使い下さい。  
同梱された電源コードは、他の製品では使用出来ません。

## GS Statement (Germany)

Das Gerät ist nicht für die Benutzung im unmittelbaren Gesichtsfeld am Bildschirmarbeitsplatz vorgesehen. Um störende Reflexionen am Bildschirmarbeitsplatz zu vermeiden, darf dieses Produkt nicht im unmittelbaren Gesichtsfeld platziert werden.

# Declaration of conformity



## DECLARATION OF CONFORMITY

according to ISO/IEC 170501 and EN 170501

**DoC #: SDG08-1401-01**

**Supplier's Name:** Hewlett-Packard Company  
**Supplier's Address:** 16399 West Bernardo Drive, San Diego, CA 92127 -1899, USA  
**declares, that the product**  
**Product Name and Model:**<sup>2)</sup> HP ENVY 5640 e-All-in-One Printer Series  
HP ENVY 5660 e-All-in-One Printer Series  
**Regulatory Model Number:**<sup>1)</sup> SDG08-1401-01  
**Product Options:** All  
**Radio Module:** SDG08-1391 (802.11 b/g/n)  
**Power Adapter:** N/A  
**conforms to the following Product Specifications and Regulations:**

**EMC:** Class B

CISPR 22:2008 / EN 55022: 2010 Class B  
CISPR 24:2010 / EN 55024: 2010  
EN 301 489 -1 v1.9.2  
EN 301 489 -17 v2.2.1  
IEC 61000 -3-2: 2005 + A1: 2008 + A2: 2009 / EN 61000 -3-2: 2006 + A1:2009 + A2:2009  
IEC 61000 -3-3: 2008 / EN 61000 -3-3: 2008  
FCC CFR 47 Part 15 / ICES-003, issue 5 Class B

**Safety:**

IEC 60950 -1: 2005 + A1: 2009 / EN 60950 -1: 2006 + A11: 2009 + A1: 2010 + A12: 2011  
EN 62479: 2010

**Energy Use:**

Regulation (EC) No. 1275/2008  
ENERGY STAR® Qualified Imaging Equipment Operational Mode (OM) Test Procedure

**RoHS:**

EN 50581:2012

The product herewith complies with the requirements of the Low Voltage Directive 2006/95/EC, the EMC Directive 2004/108/EC, the R&TTE Directive 1999/5/EC, the Ecodesign Directive 2009/125/EC, the RoHS Directive 2011/65/EU and carries the  marking accordingly.

This device complies with part 15 of the FCC Rules. Operation is subject to the following two conditions:

(1) This device may not cause harmful interference, and (2) this device must accept any interference received, including interference that may cause undesired operation.

**Additional Information:**

1) This product is assigned a Regulatory Model Number which stays with the regulatory aspects of the design. The Regulatory Model Number is the main product identifier in the regulatory documentation and test reports, this number should not be confused with the marketing name or the product numbers.

**January 2014**

San Diego, CA

**Local contact for regulatory topics only:**

EU: Hewlett-Packard GmbH, HQ -TRE, Herrenberger Strasse 140, 71034 Boeblingen, Germany  
U.S.: Hewlett-Packard, 3000 Hanover St., Palo Alto, CA 94304, U.S.A. 650-857-1501

[www.hp.eu/certificates](http://www.hp.eu/certificates)

## Regulatory information for wireless products

This section contains the following regulatory information pertaining to wireless products:

- [Exposure to radio frequency radiation](#)
- [Notice to users in Brazil](#)
- [Notice to users in Canada](#)
- [Notice to users in Taiwan](#)
- [Notice to users in Mexico](#)
- [Wireless notice to users in Japan](#)

### Exposure to radio frequency radiation

#### **Exposure to radio frequency radiation**



**Caution** The radiated output power of this device is far below the FCC radio frequency exposure limits. Nevertheless, the device shall be used in such a manner that the potential for human contact during normal operation is minimized. This product and any attached external antenna, if supported, shall be placed in such a manner to minimize the potential for human contact during normal operation. In order to avoid the possibility of exceeding the FCC radio frequency exposure limits, human proximity to the antenna shall not be less than 20 cm (8 inches) during normal operation.

### Notice to users in Brazil

#### **Aviso aos usuários no Brasil**

Este equipamento opera em caráter secundário, isto é, não tem direito à proteção contra interferência prejudicial, mesmo de estações do mesmo tipo, e não pode causar interferência a sistemas operando em caráter primário.

## Notice to users in Canada

### **Notice to users in Canada/Note à l'attention des utilisateurs canadiens**

Under Industry Canada regulations, this radio transmitter may only operate using an antenna of a type and maximum (or lesser) gain approved for the transmitter by Industry Canada. To reduce potential radio interference to other users, the antenna type and its gain should be so chosen that the equivalent isotropically radiated power (e.i.r.p.) is not more than that necessary for successful communication.

This device complies with Industry Canada licence-exempt RSS standard(s). Operation is subject to the following two conditions: (1) this device may not cause interference, and (2) this device must accept any interference, including interference that may cause undesired operation of the device.

**WARNING!** Exposure to Radio Frequency Radiation The radiated output power of this device is below the Industry Canada radio frequency exposure limits. Nevertheless, the device should be used in such a manner that the potential for human contact is minimized during normal operation.

To avoid the possibility of exceeding the Industry Canada radio frequency exposure limits, human proximity to the antennas should not be less than 20 cm (8 inches).

Conformément au Règlement d'Industrie Canada, cet émetteur radioélectrique ne peut fonctionner qu'avec une antenne d'un type et d'un gain maximum (ou moindre) approuvé par Industrie Canada. Afin de réduire le brouillage radioélectrique potentiel pour d'autres utilisateurs, le type d'antenne et son gain doivent être choisis de manière à ce que la puissance isotrope rayonnée équivalente (p.i.r.e.) ne dépasse pas celle nécessaire à une communication réussie.

Cet appareil est conforme aux normes RSS exemptes de licence d'Industrie Canada. Son fonctionnement dépend des deux conditions suivantes : (1) cet appareil ne doit pas provoquer d'interférences nuisibles et (2) doit accepter toutes interférences reçues, y compris des interférences pouvant provoquer un fonctionnement non souhaité de l'appareil.

**AVERTISSEMENT** relatif à l'exposition aux radiofréquences. La puissance de rayonnement de cet appareil se trouve sous les limites d'exposition de radiofréquences d'Industrie Canada. Néanmoins, cet appareil doit être utilisé de telle sorte qu'il soit mis en contact le moins possible avec le corps humain.

Afin d'éviter le dépassement éventuel des limites d'exposition aux radiofréquences d'Industrie Canada, il est recommandé de maintenir une distance de plus de 20 cm entre les antennes et l'utilisateur.

## Notice to users in Taiwan

### **低功率電波輻射性電機管理辦法**

#### **第十二條**

經型式認證合格之低功率射頻電機，非經許可，公司、商號或使用者均不得擅自變更頻率、加大功率或變更設計之特性及功能。

#### **第十四條**

低功率射頻電機之使用不得影響飛航安全及干擾合法通信；經發現有干擾現象時，應立即停用，並改善至無干擾時方得繼續使用。

前項合法通信，指依電信法規定作業之無線電通信。低功率射頻電機須忍受合法通信或工業、科學及醫藥用電波輻射性電機設備之干擾。

## Notice to users in Mexico

### **Aviso para los usuarios de México**

La operación de este equipo está sujeta a las siguientes dos condiciones: (1) es posible que este equipo o dispositivo no cause interferencia perjudicial y (2) este equipo o dispositivo debe aceptar cualquier interferencia, incluyendo la que pueda causar su operación no deseada.

Para saber el modelo de la tarjeta inalámbrica utilizada, revise la etiqueta regulatoria de la impresora.

## Wireless notice to users in Japan

この機器は技術基準適合証明又は工事設計認証を受けた無線設備を搭載しています。

---

## B Errors (Windows)

- [Low on ink](#)
- [Very low on ink](#)
- [Ink cartridge problem](#)
- [Check cartridge access door](#)
- [Ink cartridge problem](#)
- [Paper size mismatch](#)
- [Ink cartridge carriage stalled](#)
- [Paper jam or tray problem](#)
- [Out of paper](#)
- [Document failed to print](#)
- [Printer failure](#)
- [Door open](#)
- [Ink cartridge failure](#)
- [Counterfeit Cartridge Advisory](#)
- [Incompatible ink cartridges](#)
- [Paper too short](#)
- [Paper too long to auto-duplex](#)
- [Incompatible HP Instant Ink Cartridge](#)
- [Used HP Instant Ink Cartridge](#)
- [Please Connect Printer to HP Connected](#)
- [Cannot Print](#)
- [HP Protected Cartridge Installed](#)

## Low on ink

The ink cartridge identified in the message is low on ink.

Ink level warnings and indicators provide estimates for planning purposes only. When you receive a low ink warning message, consider having a replacement cartridge available to avoid possible printing delays. You do not need to replace cartridges until the print quality becomes unacceptable.

For information about replacing ink cartridges, see [Replace the cartridges on page 49](#). For information about ordering ink cartridges, see [Order ink supplies on page 51](#).



**NOTE:** Ink from the cartridges is used in the printing process in a number of different ways, including in the initialization process, which prepares the printer and cartridges for printing. In addition, some residual ink is left in the cartridge after it is used. For more information see [www.hp.com/go/inkusage](http://www.hp.com/go/inkusage).

---



## Very low on ink

The ink cartridge identified in the message is very low on ink.

Ink level warnings and indicators provide estimates for planning purposes only. When you receive a very low ink warning message, HP recommends having a replacement cartridge available to avoid possible printing delays. You do not need to replace cartridges until the print quality is unacceptable.

For information about replacing ink cartridges, see [Replace the cartridges on page 49](#). For information about ordering ink cartridges, see [Order ink supplies on page 51](#).



**NOTE:** Ink from the cartridges is used in the printing process in a number of different ways, including in the initialization process, which prepares the printer and cartridges for printing. In addition, some residual ink is left in the cartridge after it is used. For more information see [www.hp.com/go/inkusage](http://www.hp.com/go/inkusage).

---

## Ink cartridge problem

The ink cartridge identified in the message is missing, damaged, incompatible, or inserted into the wrong slot in the printer.



**NOTE:** If the cartridge is identified in the message as incompatible, see [Order ink supplies on page 51](#) for information about obtaining cartridges for the printer.

---

To solve this problem, try the following solutions. Solutions are listed in order, with the most likely solution first. If the first solution does not solve the problem, continue trying the remaining solutions until the issue is resolved.

- Solution 1: Turn the printer off and on.
- Solution 2: Install the ink cartridges correctly.

### **Solution 1: Turn the printer off and on**

Turn off the printer, and then turn it on again.

If the problem persists, try the next solution.

### **Solution 2: Install the ink cartridges correctly**

Make sure all of the ink cartridges are properly installed:

1. Gently pull open the ink cartridge access door.
2. Remove the ink cartridge by pushing it in to release it, and then pulling it firmly toward you.
3. Insert the cartridge into the slot. Press firmly on the cartridge to ensure proper contact.
4. Close the ink cartridge access door and check if the error message has gone away.

## Check cartridge access door

The cartridge access door should be closed for printing.



 [Click here to go online for more information.](#)

## Ink cartridge problem

The ink cartridge is not compatible with your printer. This error can occur if you install an HP Instant Ink cartridge into a printer that has not been enrolled in the HP Instant Ink program. It can also occur if the HP Instant Ink cartridge was previously used in a different printer enrolled in the HP Instant Ink program.

## Paper size mismatch

The paper size or type selected in the printer driver does not match the paper loaded in the printer. Make sure that the correct paper is loaded in the printer, and then print the document again. For more information, see [Load media on page 11](#).



---

**NOTE:** If the paper loaded in the printer is the correct size, change the selected paper size in the printer driver, and then print the document again.

---

## Ink cartridge carriage stalled

Something is blocking the ink cartridge carriage (the part of the printer that holds the ink cartridges).

To clear the obstruction check the printer for jams.

For more information, see [Jams and paper-feed issues on page 67](#).

## Paper jam or tray problem

Paper has become jammed in the printer.

Before you try to clear the jam, check the following:

- Make sure that you have loaded paper that meets specifications and is not wrinkled, folded, or damaged. For more information, see [Paper basics on page 8](#).
- Make sure that the printer is clean.
- Make sure that the trays are loaded correctly and are not too full. For more information, see [Load media on page 11](#).

For instructions on clearing jams, as well as more information about how to avoid jams, see [Jams and paper-feed issues on page 67](#).

## Out of paper

The default tray is empty.

Load more paper, and then touch **OK**.

For more information, see [Load media on page 11](#).





## Document failed to print

The printer could not print the document because a problem occurred in the printing system.

For information about solving printing problems, see [Printer hardware issues on page 86](#).

## Printer failure

There was a problem with the printer or ink system. Usually, you can resolve such problems by completing the following steps:

1. Press  (the Power button) to turn off the printer.
2. Unplug the power cord, and then plug in the power cord again.
3. Press  (the Power button) to turn on the printer.

If this problem persists, write down the error code provided in the message, and then contact HP support. For more information about contacting HP support, see [HP support on page 88](#).

## Door open

Before the printer can print documents, all doors and covers must be closed.

---

 **TIP:** When completely closed, most doors and covers snap into place.

---

If the problem persists after you've securely closed all doors and covers, contact HP support. For more information, see [HP support on page 88](#).

## Ink cartridge failure

The cartridges listed in the message are damaged or have failed.

See [Replace the cartridges on page 49](#).

## Counterfeit Cartridge Advisory

The installed cartridge is not a new, genuine HP cartridge. Contact the store where this cartridge was purchased. To report suspected fraud, visit HP at [www.hp.com/go/anticounterfeit](http://www.hp.com/go/anticounterfeit). To continue using the cartridge, click **Continue**.

## Incompatible ink cartridges

The ink cartridge is not compatible with your printer.

Solution: Remove this cartridge immediately and replace with a compatible ink cartridge. For information about how to install new cartridges, see [Replace the cartridges on page 49](#).

## Paper too short

The paper loaded is shorter than the minimum requirement. Paper that meets the printer requirements must be loaded. For more information, see [Paper basics on page 8](#) and [Load media on page 11](#).

## Paper too long to auto-duplex

The paper loaded is longer than supported by the printer automatic duplexing. You can manually duplex it by selecting "manual duplex" or "print odd pages" and "print even pages" in your printer software (if supported). For more information, see [Paper basics on page 8](#) and [Load media on page 11](#).



## Incompatible HP Instant Ink Cartridge

This cartridge can only be used in a printer that is currently enrolled in HP Instant Ink.

If you believe your printer should accept this cartridge, please contact [www.hp.com/buy/supplies](http://www.hp.com/buy/supplies).

## Used HP Instant Ink Cartridge

The HP Instant Ink cartridge(s) listed on the printer control panel display can only be used in the HP Instant Ink printer that initially installed the cartridge. The cartridge must be replaced.

For information about replacing ink cartridges, see [Replace the cartridges on page 49](#). For information about ordering ink cartridges, see [Order ink supplies on page 51](#).

## Please Connect Printer to HP Connected

The printer must be connected to HP Connected, otherwise you will be unable to print soon without further warning. See the printer control panel for instructions on connecting.

## Cannot Print

The printer needs to be connected to HP Connected to update its Instant Ink status.

You will be unable to print until the printer has been connected to update the Instant Ink status. See the printer control panel for instructions on connecting.

## HP Protected Cartridge Installed

The ink cartridge listed on the printer control panel can only be used in the printer that initially protected the cartridge using the HP Cartridge Protection feature. The ink cartridge must be replaced in this printer.

For information about how to install a new ink cartridge, see [Replace the cartridges on page 49](#).

---

# Index

- A**
  - accessibility 19
  - after the support period 89
- B**
  - both sides, print on 24
  - buttons, control panel 5
- C**
  - carriage
    - clear carriage jams 69
  - connectors, locating 4
  - control panel
    - buttons 5
    - features 5
    - lights 5
    - status icons 6
  - copy
    - specifications 93
  - customer support
    - warranty 89
- D**
  - double-sided printing 24
- E**
  - embedded web server
    - Webscan 44
  - environment
    - Environmental product stewardship program 94
    - environmental specifications 92
- G**
  - glass, scanner
    - locating 3
- H**
  - Help button 6
- HP Utility (OS X)**
  - opening 63
- I**
  - ink cartridges 4
  - IP settings 62
- J**
  - jams
    - clear 67
    - paper to avoid 10
- L**
  - lights, control panel 5
- M**
  - media
    - duplexing 24
  - multi-feeds, troubleshoot 71
- N**
  - networks
    - connector illustration 4
    - IP settings 62
    - settings, change 62
    - wireless communication setup 57
- O**
  - OS X
    - HP Utility 63
  - output tray
    - locating 3
- P**
  - paper
    - clear jams 67
    - HP, order 10
    - selecting 10
    - skewed pages 71
    - troubleshoot feeding 70
  - paper-feed problems,
    - troubleshoot 70
  - phone support 88
  - phone support period
    - period for support 89
  - power
    - troubleshoot 86
  - power input, locating 4
  - print
    - double-sided 24
    - specifications 92
    - troubleshoot 86
  - printer control panel
    - locating 3
    - network settings 62
  - printer software (Windows)
    - about 63
    - opening 16, 63
- R**
  - radio interference
    - regulatory information 102
  - rear access panel
    - illustration 4
  - recycle
    - ink cartridges 95
  - regulatory information 98, 102
  - regulatory notices
    - regulatory model identification number 98
- S**
  - scan
    - from Webscan 44
    - scan specifications 92
  - scanner glass
    - locating 3

- settings
  - network 62
- skew, troubleshoot
  - print 71
- software
  - Webscan 44
- status icons 6
- support process 88
- system requirements 92

## T

- technical information
  - copy specifications 93
  - environmental specifications 92
  - print specifications 92
  - scan specifications 92
  - system requirements 92
- trays
  - clear paper jams 67
  - locating 3
  - paper-width guides
    - illustration 3
  - troubleshoot feeding 70
- troubleshoot
  - multiple pages are picked 71
  - paper not picked up from tray 70
  - paper-feed problems 70
  - power 86
  - print 86
  - skewed pages 71
- two-sided printing 24

## U

- USB connection
  - port, locating 3, 4

## W

- warranty 89
- Webscan 44
- websites
  - accessibility information 19
- wireless communication
  - regulatory information 102
  - set up 57