



POCKET ⚡ POWER™ 6000

Universal Power Charger



Operating Instructions

Content

Warning	3-5
Illustration	6
Accessories	7
Operation Instructions	8
Specifications	9
Features	10-11
Demonstration	12-14

If the power charger does NOT charge your mobile phone when the micro USB connector is connected to your mobile phone, please restart the power charger while it is connected to your mobile phone (please refer to page 8 for details).

Read all safety information and operating instructions before using this HALO charger to avoid possible injury and damage to your device. We assume no responsibility for damage to charged devices due to improper operations of this power charger.

How to Handle

Do not drop, disassemble, open, crush, bend, deform, puncture, shred, microwave, incinerate, paint, or insert foreign objects into the HALO charger.

Safety Information

Do not get the HALO charger wet. In case it does get wet, unplug all cables and turn off power, by pressing the power button for three seconds. Allow it to dry thoroughly before turning it on again. Do not attempt to dry the power charger with an external heat source, such as a microwave or hair dryer. A power charger that has been damaged as a result of exposure to liquids is not serviceable.

Repair and Modification

Never attempt to repair or modify your HALO charger yourself. Disassembling this power charger, including the removal of external screws, may cause damage that is not covered under the warranty. If this power charger has been submerged in water, punctured, or dropped, do not use it.

Battery Replacement

The rechargeable battery in your HALO charger should be replaced only by HALO2CLOUD, LLC.

How to Recharge

Please use the built-in USB input connector to recharge the HALO charger.

How to Use Connectors and Ports

Never force a connector into a port. If the connector and port do not easily join, check for obstructions in the port. If there are no visible obstructions, make sure that the connector matches the port and that you have positioned the connector correctly in relation to the port.

How to Reboot

If there is an unexpected short circuit, the HALO charger will shut down as a protective measure. In case this happens, use the built-in USB cable, not the power button, to reboot/turn on the HALO charger.

Device and Accessories

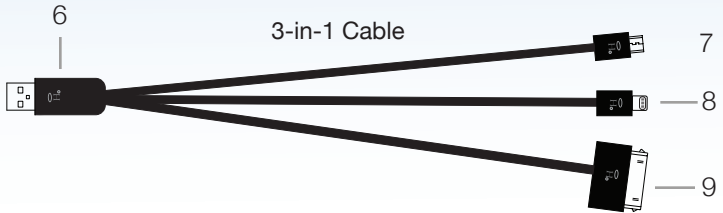
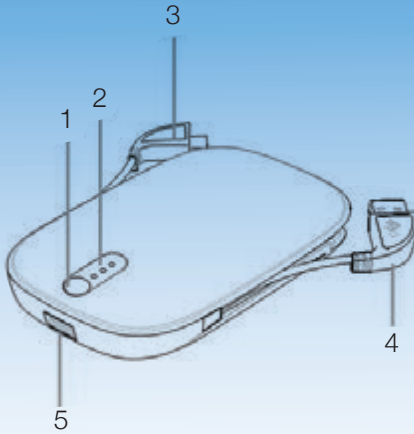

1. Power button (turn ON/OFF)
2. LED power indicator lights
3. Micro USB output connector (5V/1A)
4. Recharge USB input connector
5. USB output port (5V/2A)
6. Standard USB tip
7. Micro USB tip
8. Lightning tip
9. 30-Pin tip

To Turn On/Off the HALO Pocket Power 6000

To start, press and hold the power button for three seconds. The three LED lights will blink for five seconds when the device is turned on. Press the power button for three seconds to turn off.

Charge the HALO Pocket Power 6000

Connect the USB input connector (#4 on illustration) to the Standard USB port on your computer or an AC adapter that accepts Standard USB.

Charge your Personal Electronic Device

For electronic devices with a micro USB input, insert the Micro USB output port (#3 on illustration) directly into your device.

For electronic devices with a 30-pin input, use the supplied 3-in-1 cable. Plug the Standard USB end of the 3-in-1 cable into the USB output port (#5 on illustration) of the HALO charger and the 30-pin tip into your electronic device.

For electronic devices with a Lightning port, use the supplied 3-in-1 cable. Plug the Standard USB end of the 3-in-1 cable into the USB output port (#5 on illustration) of the HALO charger and the Lightning tip into your electronic device.

You can also charge two devices at one time by using both the Micro USB output connector (#3 on illustration) and the 3-in-1 cable, plugged into the USB output port (#5 on illustration).

Battery Capacity Indicator

With the power off, press and release the power button to track the remaining battery capacity.

Intelligent Recognition

The HALO charger is programmed with an intelligent recognition system to achieve higher compatibility for charging different mobile phones. If it does not charge when the micro USB connector is connected to your mobile phone, please restart the power charger.

Specifications

Battery Cell: Rechargeable lithium polymer

Capacity: 6000 mAh

Input: 5V/1A

Micro USB output: 5V/1A

USB output: 5V/2A

Dimensions: 4.6" x 3" x 0.7" (116 x 78 x 18mm)

Compatible with:

Mobile phones, Tablets, PSP, NDS, MP3, MP4, MP5, Bluetooth GPS, Cameras and more



MOBILE PHONES



TABLETS



CAMERAS



GPS



GAMING



MP3

Features

- Lithium Polymer battery pack with high safety and stability.
- Unique Equilibrium PCBA protection ensures longer device life.
- Multiple safety protection system to ensure device safety.
- Quick charging, high working efficiency.
- Lower static power.
- Overcharge protection.
- Over discharge protection.
- Short circuit protection: if any of the output ports meets a short circuit, the power charger will shut down automatically; recharge it to restart the power charger.

Notes

- The power charger supports charging and discharging at the same times.
- If the power charger has an embedded, non-replaceable battery, do not attempt to open the power charger to remove the battery as this may cause injury and damage to the power charger.
- Please contact the local recycling facility for removal of the battery. The embedded, non-replaceable battery is designed to last the lifetime of the product.



Do not dispose of unit with general waste. Contains lithium polymer battery. Please return it to battery recycling collection center. For recycling center near you, call 1-877-2-RECYCLE.

RoHS
Compliant



1. This device complies with the Part 15 of the FCC Rules. Operation is subject to the following two conditions: (1) this device may not cause harmful interference, and (2) this device must accept any interference received, including interference that may cause undesired operation.

2. Changes or modifications not expressly approved by the party responsible for compliance could void the user's authority to operate the equipment.

Demonstration 1

Recharging the HALO Pocket Power 6000 from a computer USB port.

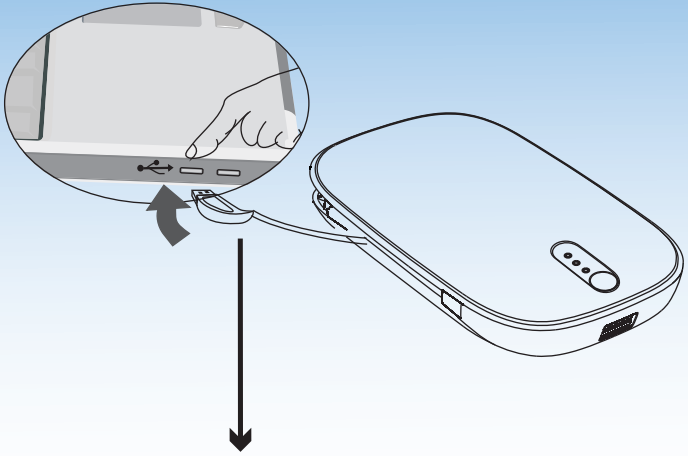

Recharge USB input connector

Demonstration 2

Charging phones (and other 5V/1A Micro USB input devices) using the Micro USB output connector (#3 on illustration).

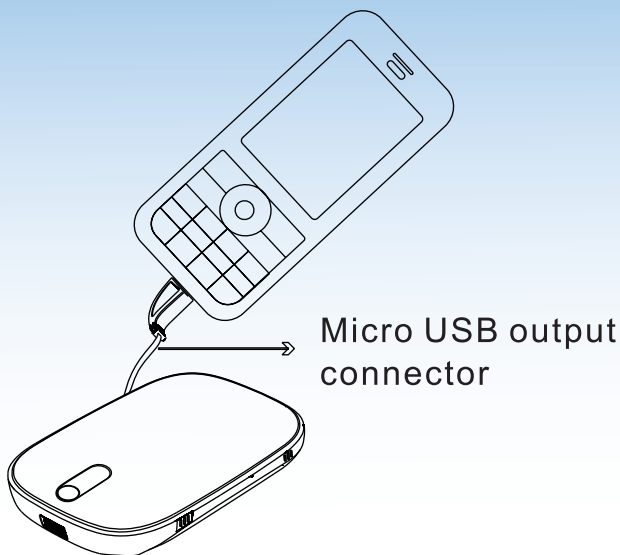

Compatible with:

Samsung Galaxy S4
Samsung Galaxy SIII
Samsung Galaxy Note II
Blackberry Z10
+ many additional models

Demonstration 3

Charging 30-pin port iPhones and iPods using the USB output port (#5 on illustration) and the 30-pin tip of the 3-in-1 cable.

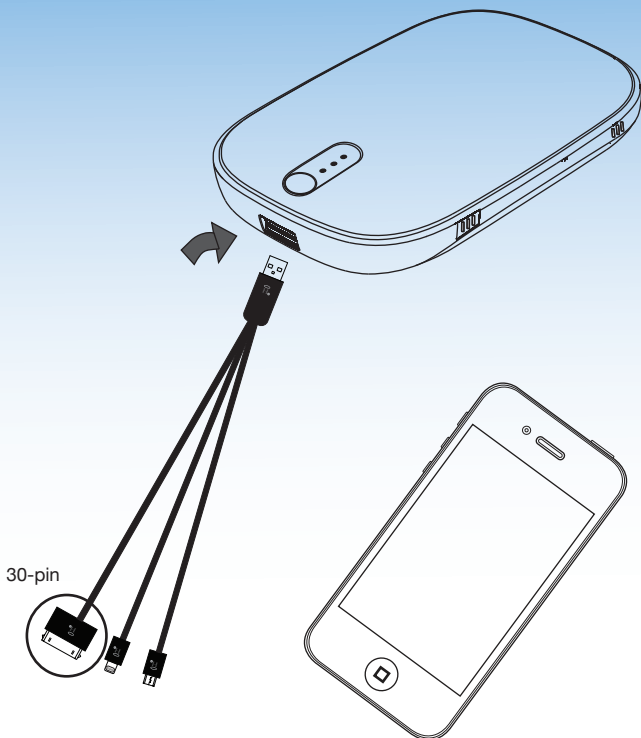

Compatible with:

iPhone 3, 4, 4s

iPad Generation 1, 2, 3

iPod family

Demonstration 4

Charging tablets (and other 5V/2A Micro USB input devices) using the USB output port (#5 on illustration) and the Micro USB tip of the 3-in-1 cable.

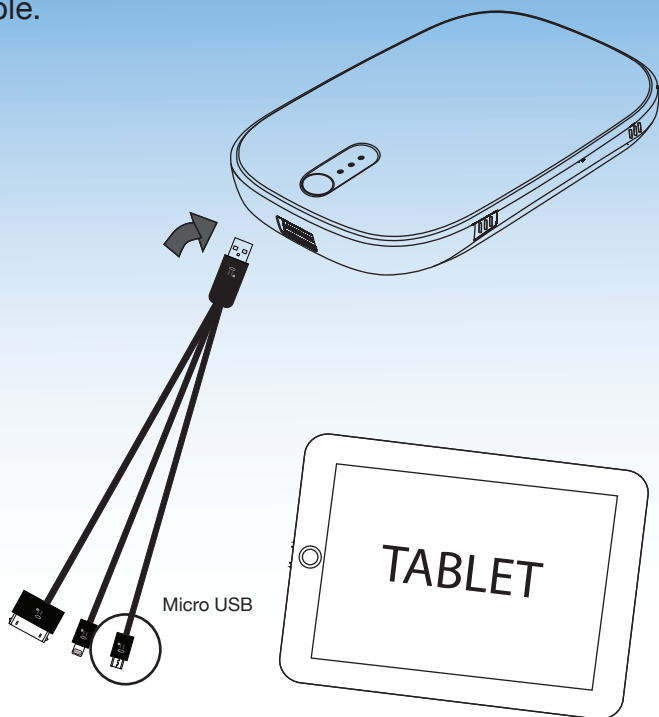

Compatible with:

Kindle Fire
Google Nexus Tablet
Blackberry Play Book
+ many additional models

For the following, please use cord provided with the device:

Nook Color
Nook/Nook HD
Samsung Galaxy Tab 2, 3

Demonstration 5

Charging Lightning port iPhones and iPads using the USB output port (#5 on illustration) and the Lightning tip of the 3-in-1 cable.

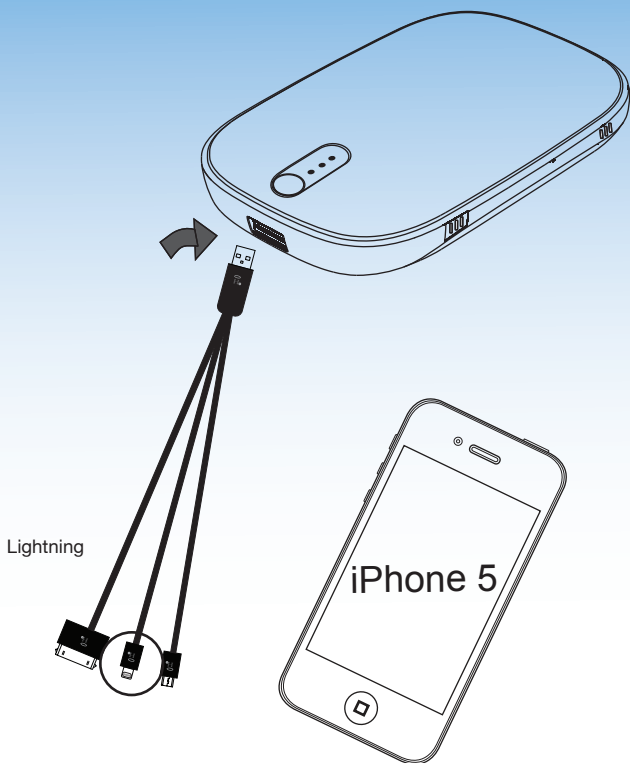

Compatible with:

iPhone 5, 5C, 5S
iPad Mini
iPad 4

Limited Warranty

HALO2CLOUD, LLC warrants its products to be free from defects in material and workmanship under normal use. Conditions are as follows:

- During the first one year from date of purchase, HALO2CLOUD, LLC will repair or replace the defective product.
- HALO2CLOUD, LLC will, subject to inspection, repair the defective product or replace it with a new or reconditioned unit. The return must be accompanied by a Return Materials Authorization (RMA) number to be issued upon request, and must be shipped prepaid. A shipping rebate will only be extended to the customer in the event that a defect in material or workmanship is confirmed.
- Warranty is void if the product has been improperly handled or misused in any way, or if the label and/or bar-coded warranty label has been removed or tampered with.
- Warranty returns require a check for \$14.95 for processing and handling made payable to HALO2CLOUD, LLC.
- Where applicable, all requests for warranty returns must be accompanied by a proof of purchase and be sent to HALO2CLOUD, LLC (www.halo2cloud.com).
- The warranty does not extend to the electronic equipment that is used or which incorporates with any of our products and accessories. HALO2CLOUD, LLC shall not be held responsible for the improper use of its products.



HALO™
HALO2CLOUD.COM